

USER MANUAL

THERMAL IMAGERS
KT-165 • KT-250 • KT-320



USER MANUAL

THERMAL IMAGERS KT-165 • KT-250 • KT-320



**SONEL S.A.
Wokulskiego 11
58-100 Świdnica, Poland**

Version 1.09 27.07.2021

Thank you for purchasing our thermal camera. KT camera is a modern, easy and safe measuring device. Please acquaint yourself with the present manual in order to avoid measuring errors and prevent possible problems related to operation of the camera.

All products of Sonel S.A. are manufactured in accordance with Quality Management System which is approved to ISO9001:2008 for the design, manufacturing, and servicing.

Due the continuous development of our products, we reserve the right to introduce changes and improvements in the thermal imaging camera and in the software described in this manual without prior notice. Illustrations presented in this manual may slightly differ from the real product.

Copyrights

© Sonel S.A. 2021. All rights reserved.

CONTENTS

1 Safety	5
2 Functional description	6
2.1 Components of the camera	6
2.2 Function buttons and screen menu	7
2.2.1 Layout of buttons	7
2.2.2 Screen	8
2.2.3 Location of information on the screen	8
3 Camera control and adjustment	9
3.1 Turning the camera or screen ON/OFF	9
3.2 Enlarging the image - Digital Zoom	10
3.3 Temperature range	10
3.4 Capturing and recording images	12
3.5 Menu, settings, functions	13
3.5.1 Full screen	14
3.5.2 Temperature analysis	15
a. Point	16
b. Area Max	16
c. Area Min	17
d. Upper isotherm	17
e. Lower isotherm	18
3.5.3 Emissivity	19
3.5.4 Palette	20
3.5.5 Temperature settings (settings of parameters for temperature measurement)	22
a. Advanced	23
b. Unit	24
c. Temperature alarm	24
3.5.6 System settings	26
a. Automatic shutdown	27
b. Time/Date	27
c. Language	29
d. Brightness	30
e. Storage	30
f. Update	31
g. WiFi Hotspot	31
h. USB Video	32
i. Reset Factory	33
j. Help	34
k. Version Code	34
3.6 Files - viewing, deleting	35
3.7 SD memory card	38
3.8 Power supply, battery charging	39
3.8.1 Removal /installation of the battery	39
3.8.2 Using the AC adapter	40
3.8.3 Power supply from the battery pack	40
3.8.4 Charging the battery pack	40
3.8.5 General rules for using Li-Ion rechargeable batteries	41
3.9 Reading data from the external memory / SD card	42
3.10 Preview of the infrared image via USB	43
3.11 Data analysis	48

4	<i>Cleaning and maintenance</i>	49
5	<i>Storing</i>	49
6	<i>Dismantling and disposal</i>	49
7	<i>Specifications</i>	50
8	<i>Standard accessories</i>	51
9	<i>Manufacturer</i>	51
10	<i>Laboratory services</i>	52
11	<i>Exemplary emissivity coefficient values</i>	53

1 Safety

Before you proceed to operate the camera, acquaint yourself thoroughly with the present manual and observe the safety regulations and specifications defined by the producer.

- Any application that differs from those specified in this manual may result in damage to the device and constitute a source of danger for the user.
- The camera must not be used in rooms where special conditions are present e.g. fire and explosion risk.
- It is forbidden to use damaged or malfunctioning camera.
- When the camera is not used for a long time, remove the batteries.
- Do not use the camera with half-closed or opened battery cover and do not use any other adapter than the one supplied with the camera.
- Repairs may be performed only by an authorised service point.

KT-165 / KT-250 / KT-320 thermal camera is designed to measure and record the images in the infrared. It is designed to provide the user with maximum performance and safety during the work. However, the following guidelines and recommendations must be observed at all times (in addition to all binding precautions applicable at individual work stands and work areas):

- Keep the camera steady when performing the measurements.
- Do not use the camera in temperatures exceeding its working and storage temperature ranges.
- **Do not direct the camera toward very high intensity radiation sources such as the sun, lasers or welding arcs etc.**
- Do not expose the camera to dust and moisture. When operating the device near water, ensure that it is adequately guarded against splashes.
- When the camera is not in use or is to be transported, ensure that the unit and its accessories are stored in the protective carry case.
- Do not re-switch on the camera until 15 seconds later after switching it off.
- Do not throw, knock or shake intensely the camera and its components in order to avoid the damage.
- Do not attempt to open the camera body, as this action will void the warranty.
- Use only the SD memory card supplied with the camera.
- During operation, if the camera is to be moved from hot/cold place to cold/hot place, e.g. from inside/outside to outside/inside of a room, switch off the camera and leave it in the new workplace for 20 minutes. Only after that time, turn it on and start normal operation with an accurate temperature measurement. Sudden and rapid changes in ambient temperature may cause fault temperature measurement and even damage camera's IR detector.
- Calibration of the detector - during operation, the camera performs auto-calibration from time to time, which takes approx. 2 seconds and which is signalled by "Calibration" message at the bottom of the screen.



- Due to continuous development of the instrument's software, the actual appearance of the display may slightly differ from the display presented in this manual.
- To maintain required parameters of rechargeable batteries, unused rechargeable batteries should be charged every 3 months. When the camera is not used for a long time, remove the batteries and store them separately.



CAUTION!

- KT-165 / KT-250 / KT-320 thermal camera has no parts that could be repaired by the user. Never attempt to disassemble or modify the camera. **Opening the device will void the warranty.**
- Use only accessories listed in **section 8**. Using other accessories does not ensure proper operation of the camera and may cause its damage.

2 Functional description

2.1 Components of the camera

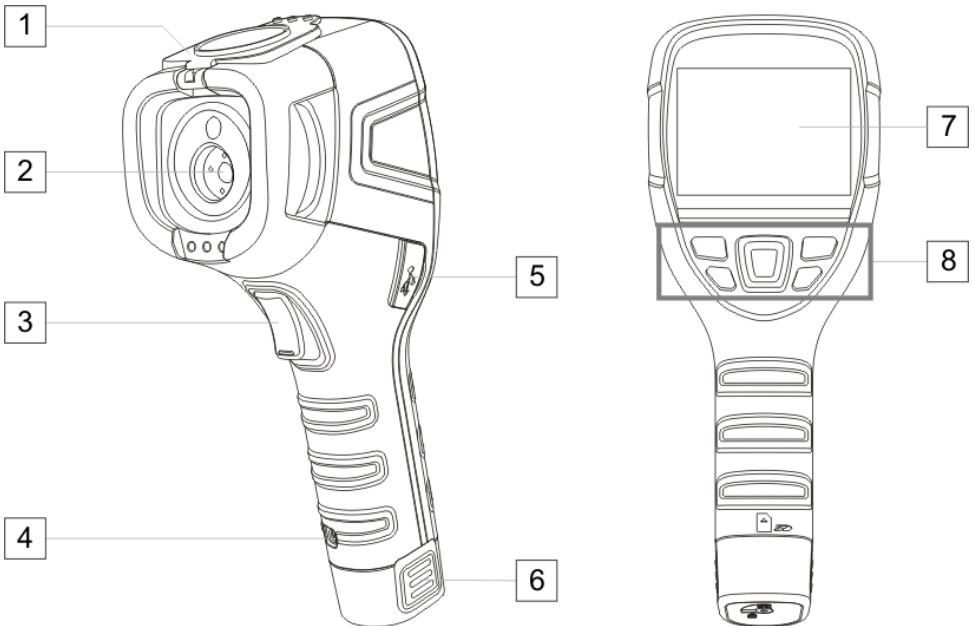

- 1 Lens cover (built-in magnet)
- 2 Lens
- 3 Trigger button
- 4 Strap holder
- 5 MicroUSB slot
- 6 Li-Ion battery (after removing it the SD card slot is accessible)
- 7 LCD display screen
- 8 Function buttons

2.2 Function buttons and screen menu

2.2.1 Layout of buttons

Camera functions are available after pressing

- the buttons located below LCD screen,
- the trigger button **3**.

The function buttons are arranged as shown in the figure below.

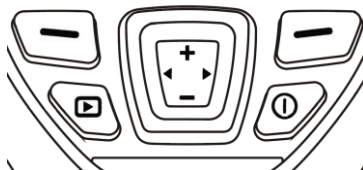

Left function button



Right function button



Button for viewing SD card contents



ON/OFF button for camera or screen



Multifunctional cursor where:



Enlarging the image / increasing selected values / cursor up



Reducing the image / decreasing selected values / cursor down



Cursor left



Cursor right

During operation of the camera, using buttons **+** or **-** it is possible to change the display mode.

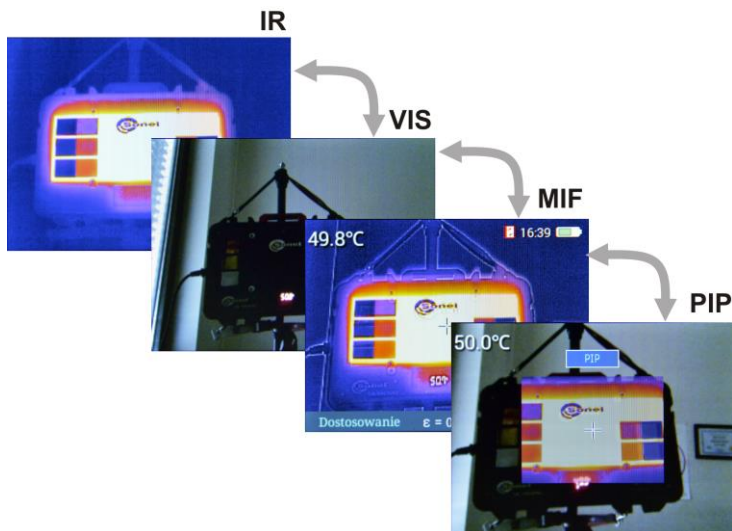

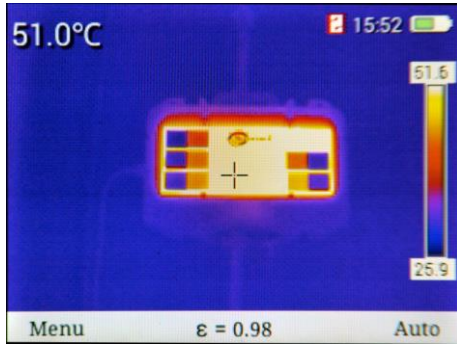

2.2.2 Screen

During operation of the camera, the infrared image is displayed in real time on the screen **7**. In the upper left corner, **the temperature of the object in the central point of the screen** is displayed for the whole time.



At the **bottom** of the screen, a **menu** is displayed, where each option may be activated by using one out of two buttons.

In the above example,  button corresponds to **Menu** command. The  button corresponds to **Auto** command.

2.2.3 Location of information on the screen

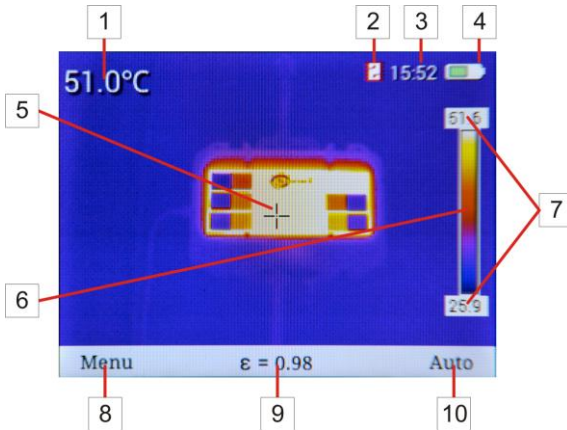



- | | | |
|--|-----------------------------------|--|
| 1 Temperature of the central point. | 5 Cursor / central point | 9 Indicator of emissivity set |
| 2 Indicator of image storage location | 6 Palette of colours | 10 Temperature range mode (auto / manual) |
| 3 Clock | 7 Temperature range | |
| 4 Battery charge indicator | 8 Entering the camera menu | |

3 Camera control and adjustment



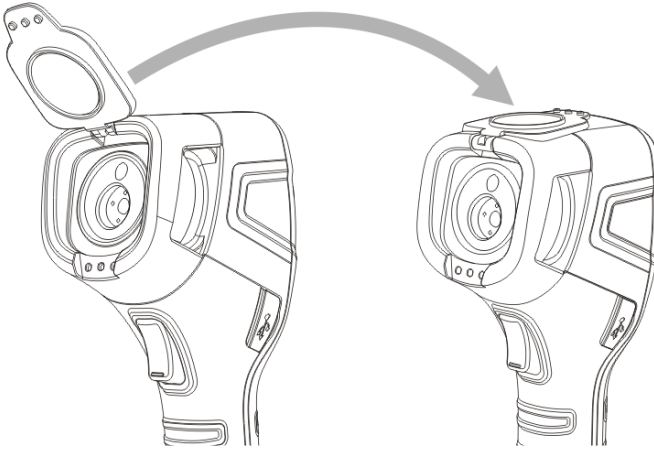

3.1 Turning the camera or screen ON/OFF

Before turning on the camera ON, open the lens cover.



In order to **switch the camera on**, press and hold  button for more than **3 sec**. The camera will display the welcome logo and commence the start-up, including the self-check. After completing the self-check, the camera is ready to work and enters the mode of real-time display of infrared image.

To **switch OFF** the camera:

- **press and hold**  button. Hold the button until the screen goes blank;
- **press and hold**  button for approx. **2 sec**. The screen will show the following message: *Power off Your camera will shut down.* To turn off the camera, use   buttons to highlight **OK** and confirm the selection using button . Select **Cancel** to exit the menu.



Shortly press  button to turn OFF only the screen. It is recommended to turn OFF the screen temporarily for short breaks in the measurements, in order to save energy. For longer breaks, we recommend to completely turn off the camera.







- The camera cannot be turned OFF in full screen mode.
- In order to eliminate possible errors in temperature readouts after turning off the camera, wait for **15 seconds** before turning it on again.

3.2 Enlarging the image - Digital Zoom

To operate the zoom function, use the cursor . When the screen shows no menu (full-screen mode, sec. 3.5.1), pressing **+** button will activate the zoom in mode – the screen image will be enlarged twice. In this mode:

- the magnification of 1-, 2- and 4-fold is available and
- access to other functions is unavailable.

The zoom magnification is indicated by   symbol or  in the upper, central part of the screen. Zoom function is operated by **+**  buttons Press  button to exit the zoom mode.

3.3 Temperature range

The camera offers manual or automatic selection of the temperature range.

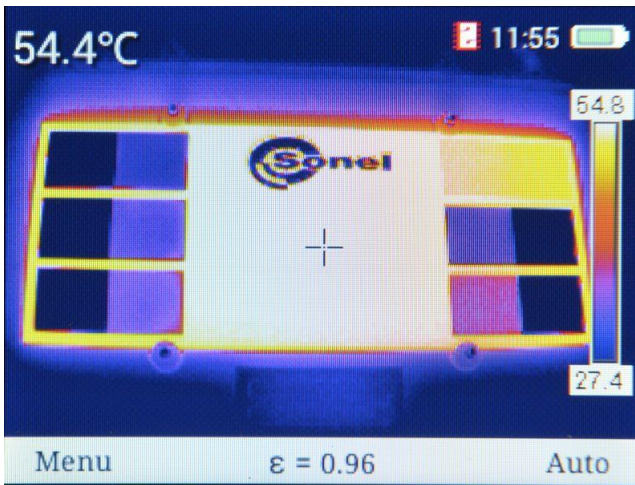

The bottom bar on the right side shows the information on the current mode of temperature range selection (**Auto** or **Manual**). Press  button to select:

- **Auto** (automatic selection of the displayed temperature range) – during the measurement, maximum and minimum temperatures will be automatically adjusted for the temperature range bar, depending on the detected temperature distribution in the observed area,
- **Semi-auto** (semi-automatic selection of the displayed temperature range) – the upper (lower) range is greater (smaller) than the central point temperature by a value set by the user,
- **Manual** (manual selection of the displayed temperature range) – entering the manual mode of selecting the temperature range.



When switching from manual to Auto mode, for it to be activated, an object with a temperature higher than the current lower range should fill the screen at least in 50%.

If the **auto**, **semi-auto**, **manual** mode is selected, this information is shown at the bottom bar.

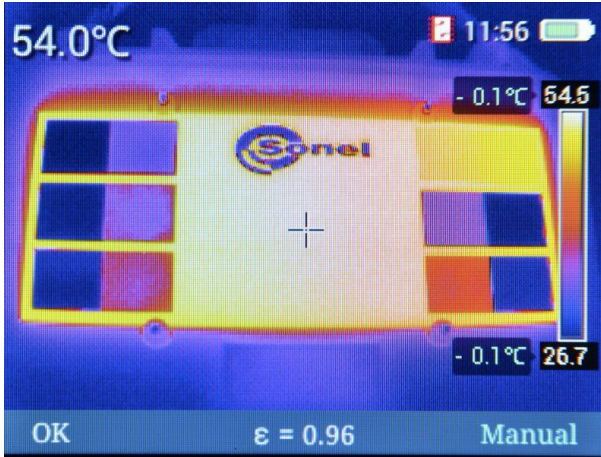

Manual mode

Press **+** or **-** buttons to **increase** or **decrease** both limits of the temperature range shown on the thermal image.

Pressing **▶** button on the cursor will **extend** the temperature range – lowering the bottom limit and increasing the upper limit.

Pressing **◀** button will **reduce** the temperature range – increasing the lower limit and lowering the upper limit.

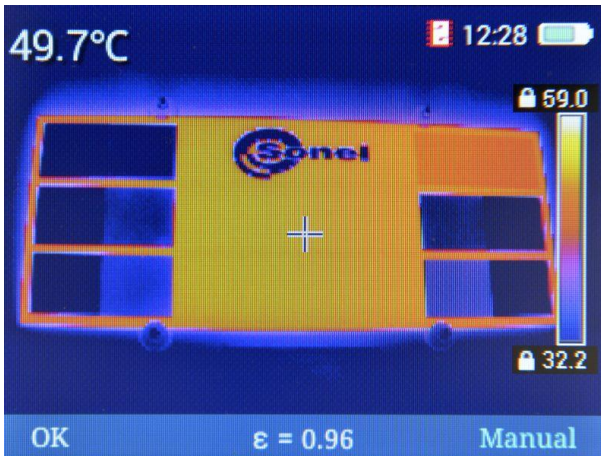

Accept the manually selected temperature range by pressing **OK** button or by a few seconds of inactivity (next to limit values, padlock symbols will be displayed)

Semi-auto mode

Press **+** or **-** buttons to **increase** or **decrease** both limits of the temperature range in reference to the central point's temperature.

Accept the manually selected temperature range by pressing **OK** button or by a few seconds of inactivity.

3.4 Capturing and recording images

①

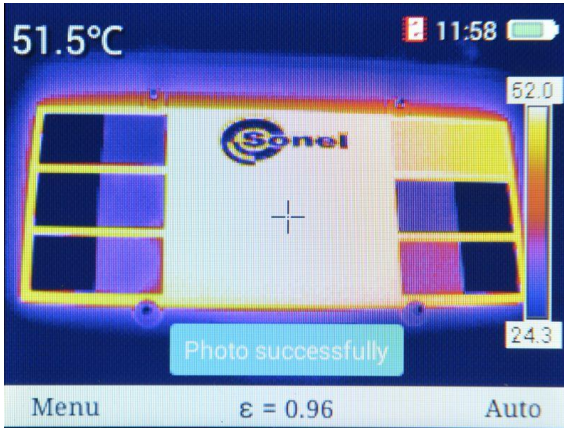

The camera displays the image in a continuous manner.

To capture an image, press the trigger button ③. This will temporarily freeze the displayed image and a message on recording the image will be displayed on the screen.

②

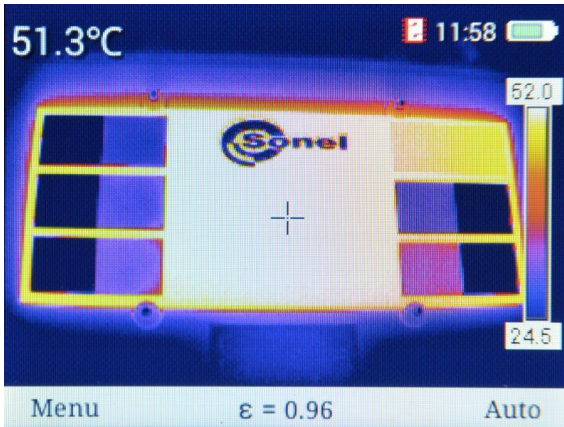



After recording the image, the camera will automatically return to the real-time display of infrared image.

3.5 Menu, settings, functions

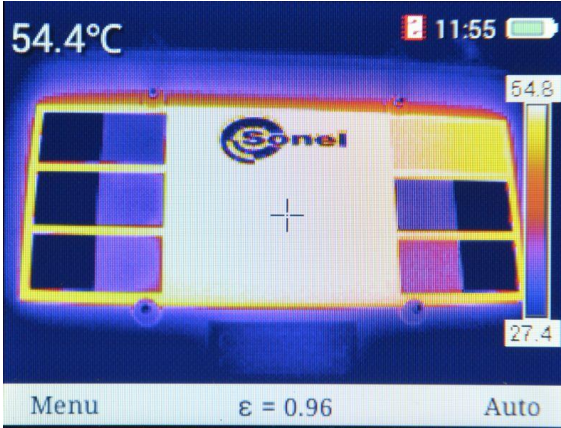
①







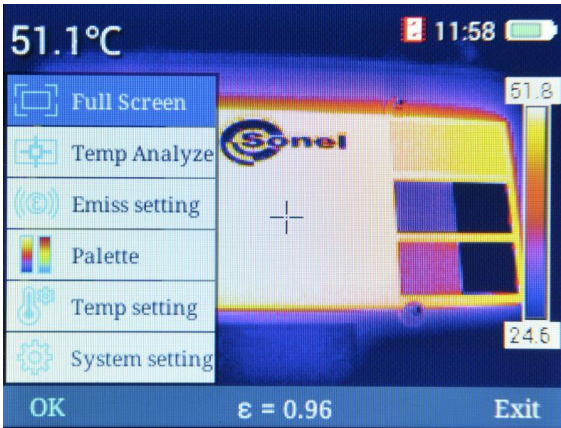

When the screen is not showing any menu, press button  or  to display the bottom bar.

②



After selecting **Menu** ( button) the main menu of the camera will be shown. It allows you to set the parameters of the camera.

The desired parameter may be **selected, with cursors** up / down (button  or ). After highlighting desired parameter, you can accept it by pressing  button (**OK**) or using the cursor . To exit, press  button (**Exit**) or cursor .

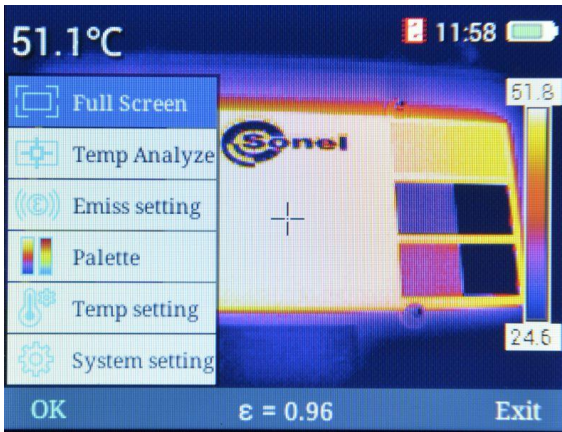

3.5.1 Full screen

- ① The screen shows the main menu of the camera.

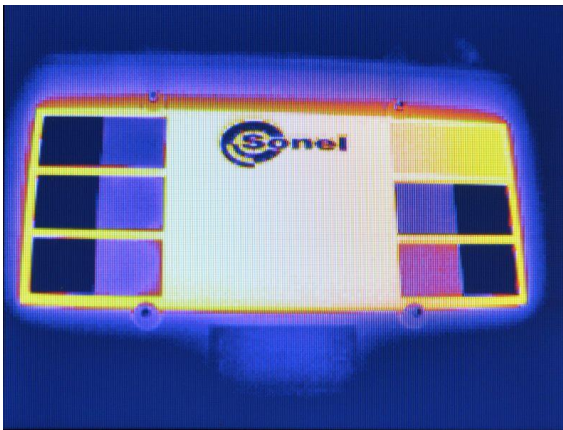

- ② To enter the full screen mode, select **Full Screen** option and accept it (**OK**).



Exit the mode by pressing  button or .

3.5.2 Temperature analysis

①

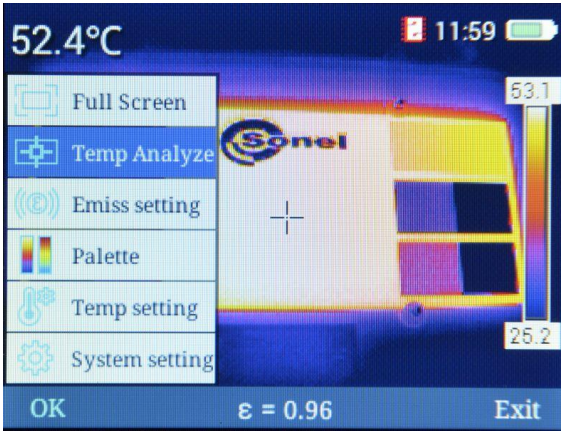

The screen shows the main menu of the camera.

②

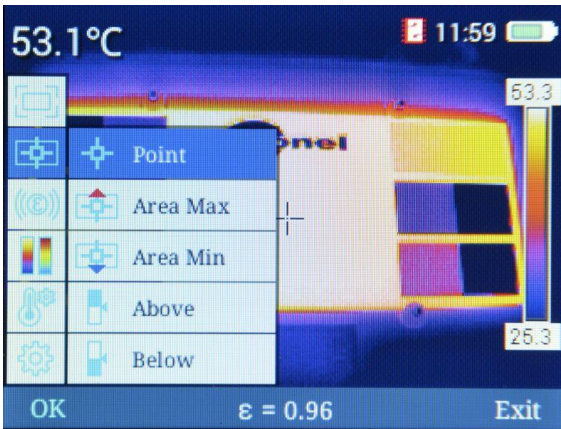

Select **Temp Analyze** option to open a sub-menu with analysis functions.

You can select one of several options.

a. Point

Select **Point**, to activate the operation in standard mode, with the cursor in the middle of the screen.

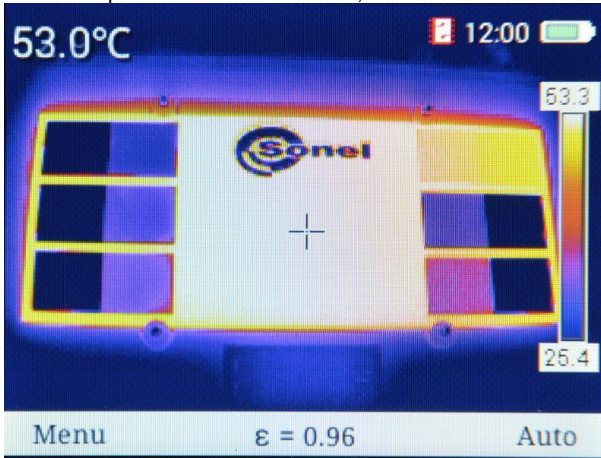

b. Area Max

Select **Area Max** to activate the temperature monitoring mode with indication of the point with the maximum temperature within the selected area.

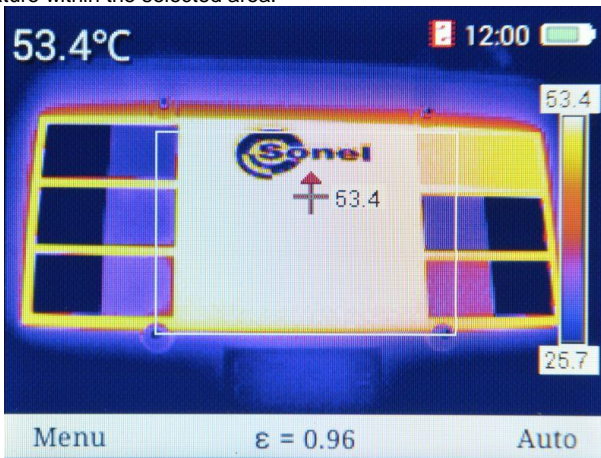

The screen will show the area selected for monitoring the maximum temperature. The cursor changes location, indicating the point of the highest temperature measured within the area. Indication of the cursor temperature is repeated next to the cursor.

If the **alarm** function is activated for maximum temperature, then after exceeding the alarm threshold the maximum temperature **indicator** (shown next to the cursor) will **change colours** (background of temperature value will change from **white** to **red**).

c. Area Min

Select **Area Min** to activate the temperature monitoring mode with indication of the point with the minimum temperature within the selected area.

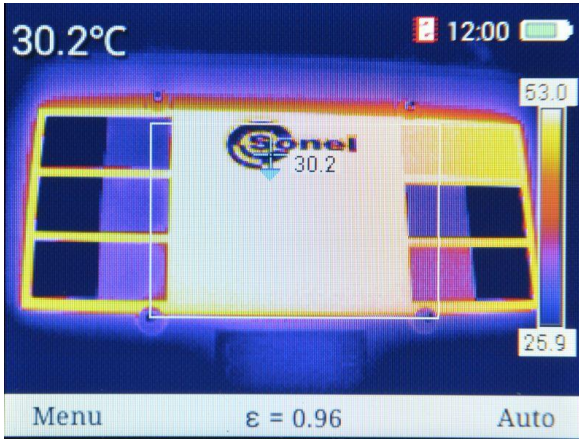

The screen will show the area selected for monitoring the minimum temperature. The cursor changes location, indicating the point of the lowest temperature measured within the area. Indication of the cursor temperature is repeated next to the cursor.

If the **alarm** function is activated for minimum temperature, then after exceeding the alarm threshold the maximum temperature **indicator** (shown next to the cursor) will **change colours** (background of temperature value will change from **white** to **blue**).

d. Upper isotherm

Select **Above** to activate isothermal analysis mode. Areas with a temperature above the set threshold are displayed in **red**.



- Selected threshold value is shown next to the indicator of the colour palette **43.9°C**. It may be **increased** or **decreased** by clicking buttons **+** or **-**.
- **Exit** the function by pressing **OK** or **Exit**.

e. Lower isotherm

Select **Below** to activate isothermal analysis mode. Areas with a temperature below the set threshold are displayed in **blue**.

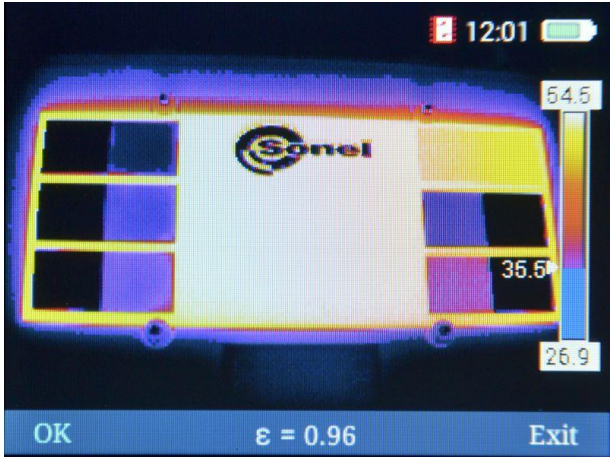

- Selected threshold value is shown next to the indicator of the colour palette **35.3**. It may be **increased** or **decreased** by clicking buttons **+** or **-**.
- **Exit** the function by pressing **-** button (**OK**) or **-** (**Exit**).

3.5.3 Emissivity

①

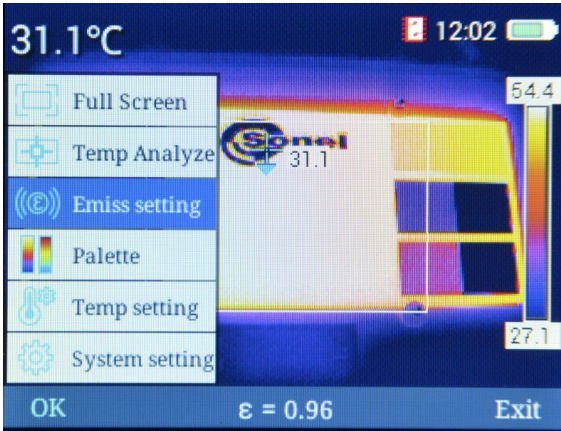

The screen shows the main menu of the camera.

②

Materials	Emiss	Materials	Emiss
Custom	0.01	Wood	0.85
Water	0.96	Brick	0.75
Stainless Steel	0.14	Tape	0.96
Aluminum Plate	0.09	Copper Plate	0.06
Black Aluminum	0.95	Human Skin	0.98
Asphalt	0.96	PVC	0.93
Black Paper	0.86	Polycarbonate	0.80
Concrete	0.97	Copper Oxide	0.78
Cast Iron	0.81	Rust	0.80
Plaster	0.75	Paint	0.90
Rubber	0.95	Soil	0.93

At the bottom of the table, there are buttons for OK, $\epsilon = 0.01$, and Exit.



Select **Emiss setting**, to open the window with settings of the emissivity factor, including the list of the most common materials and their emissivity factors (emissivity reference values).

Browse the list using **+** **-** buttons (UP/DOWN) and **◀** **▶** (LEFT/RIGHT) to select the appropriate material. Confirm the selection by pressing **OK** button. Then, you will exit to the measurement screen.

In addition, you can set any value of the emissivity factor. To do this, select **Custom** option from the list and confirm it by pressing **OK** button. The screen with the table will be closed. The measurement screen will offer the option of changing the value of emissivity factor **$\epsilon = 0.84$** by using **+** **-** buttons (UP/DOWN).

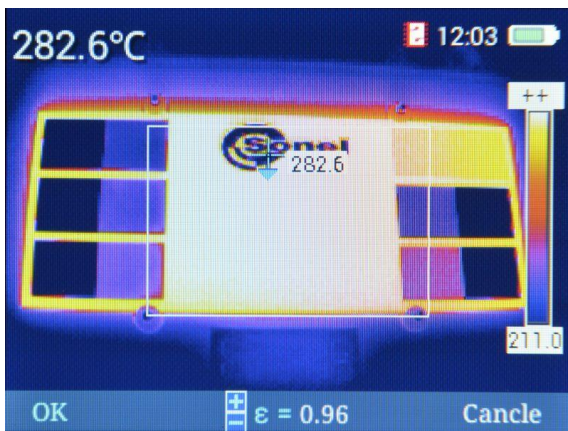
3



- Confirm the change by pressing  button (**OK**).
- Cancel the change by pressing  button (**Cancel**).

3.5.4 Palette

1

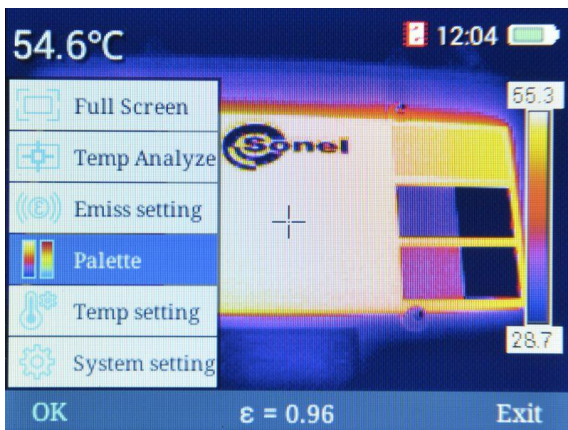



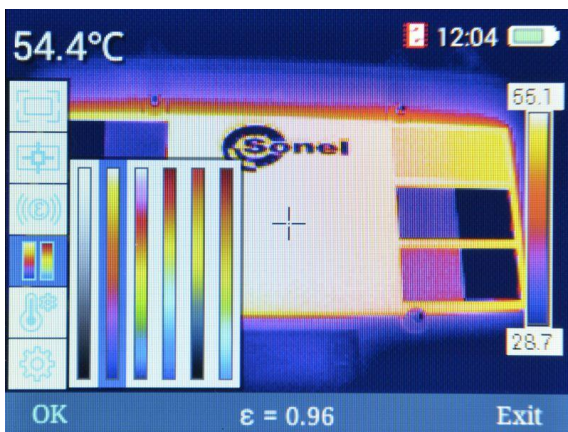

The screen shows the main menu of the camera.

Select **Palette** option to select one of the available palettes.

2



- The selection is made by using   buttons (left / right).
- Confirm the selection by pressing  button (**OK**).
- Cancel the selection by pressing  button (**Exit**).

KT-165 / KT-250 / KT-320 cameras offer six colour palettes.

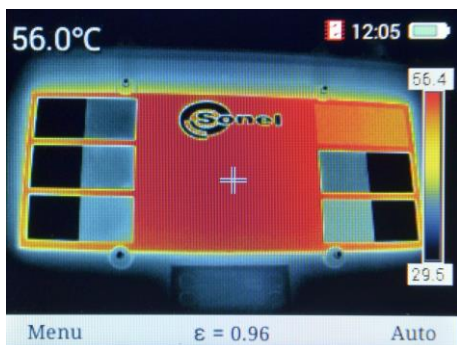
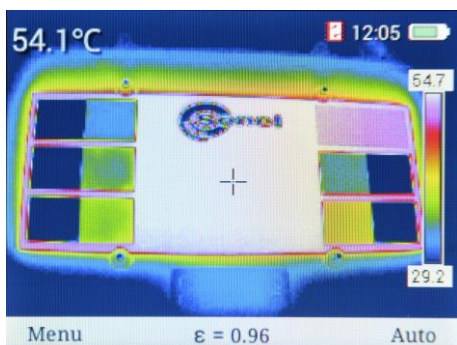
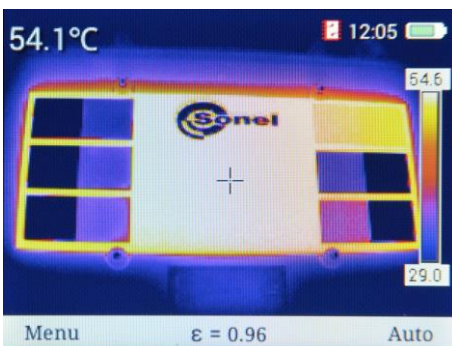
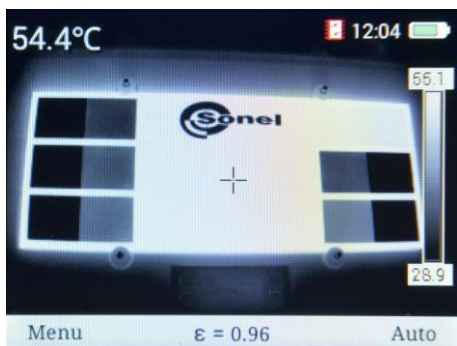

3.5.5 Temperature settings (settings of parameters for temperature measurement)

1

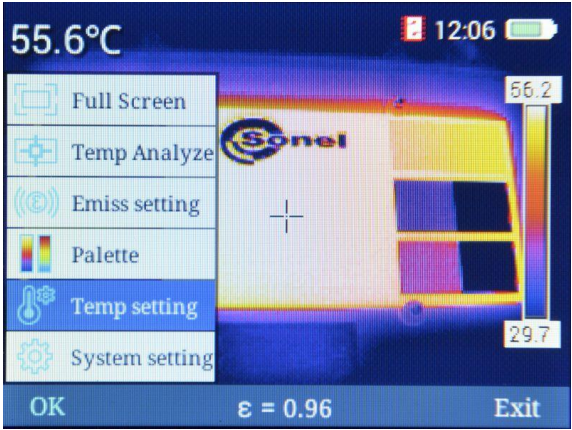

The screen shows the main menu of the camera.

2

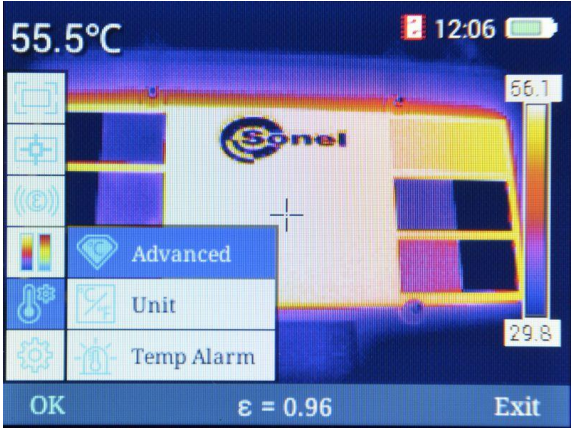

Select **Temp setting** option to open the sub-menu.

You can select one of several options.

a. Advanced

Select **Advanced** option to open the window with settings of measurement conditions, including temperature, relative humidity and the distance from the tested object.

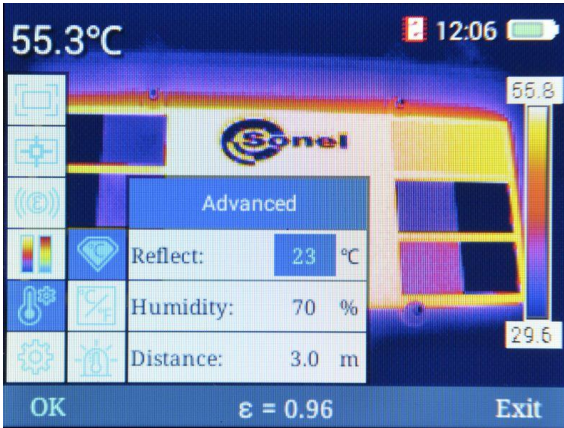

- Switch between the fields using **+** **-** buttons (UP/DOWN).
- Edit the values by selecting (highlighting) the desired field and pressing **OK** or use **▶** button. Next to the edited value, you will see mnemonic **±**.

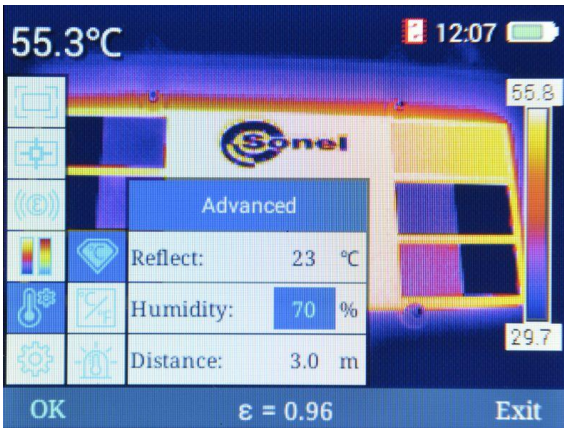

- Increase or decrease value of the parameter by pressing **+** **-** buttons (UP/DOWN).
- Confirm the changes by pressing **OK** or **◀▶**.
- Return to the measurement mode, after introducing changes, by selecting **Exit** button.

b. Unit

Select **Unit** to open the window of temperature measurement unit.

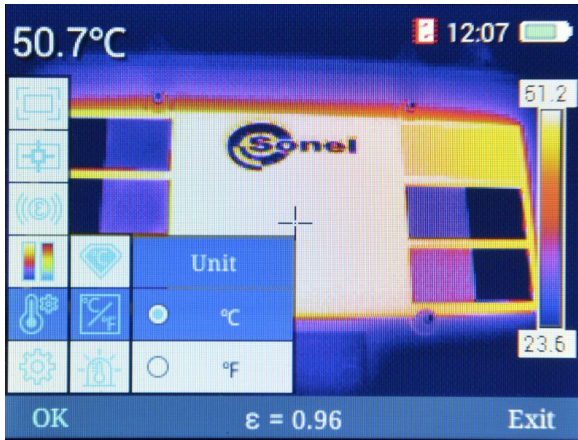

You can select from the following units:

⇒ °C – degrees Celsius,

⇒ °F – degrees Fahrenheit.

- Selection is made by pressing **+** **-** buttons (UP/DOWN).
- Confirm the changes by pressing **OK** or **▶**.
- Return without saving changes **◀**.
- Return to the measurement mode, after introducing changes, by selecting **Exit**.

c. Temperature alarm

Select **Temp Alarm** option to open the window temperature settings for the maximum and minimum alarm threshold. You may set the alarm **threshold** for **High Temp.**(when the specified value is exceeded) or **Low Temp.** temperature (when temperature falls below the specified value).

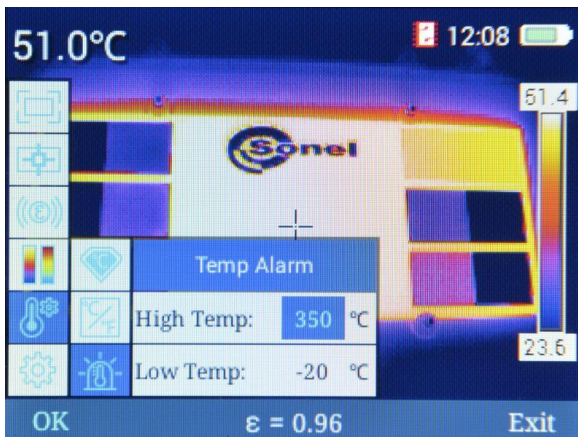

- Switch between the fields using **+** **-** buttons (UP/DOWN).
- Edit the values by selecting (highlighting) the desired field and pressing **OK** or **▶**.
Next to the edited value, you will see mnemonic **±**.

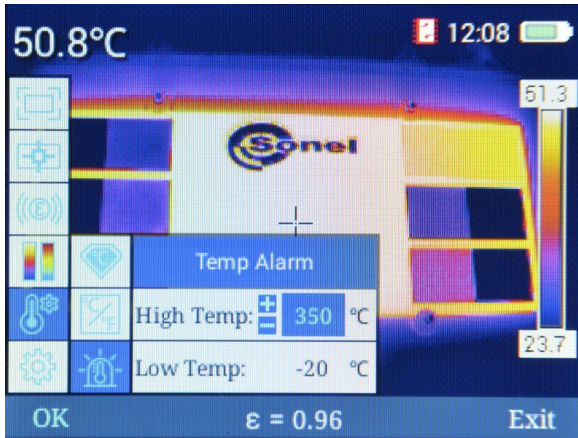

- Increase or decrease value of the parameter by pressing **+** **-** buttons (UP/DOWN).
- Confirm the changes by pressing **OK** or **▶**.
- Return without saving changes by pressing **◀** button.
- Return to the measurement mode, after introducing changes, by selecting **Exit** button.

Depending on the selected alarm type, the moving cursor on the screen in the area analysis mode will mark the point with the highest or lowest temperature value, changing colours as described in **sec. 3.5.2**.

3.5.6 System settings

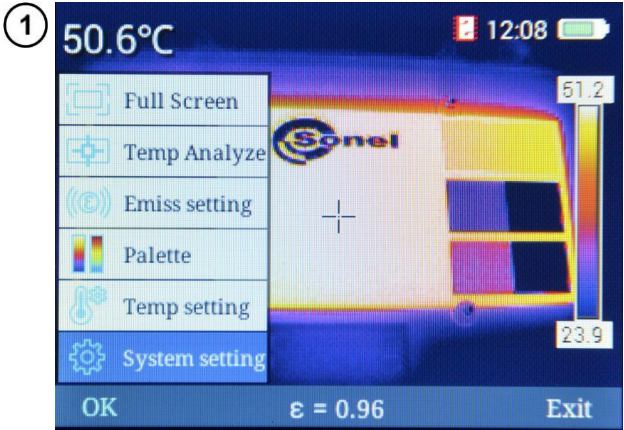

The screen shows the main menu of the camera.

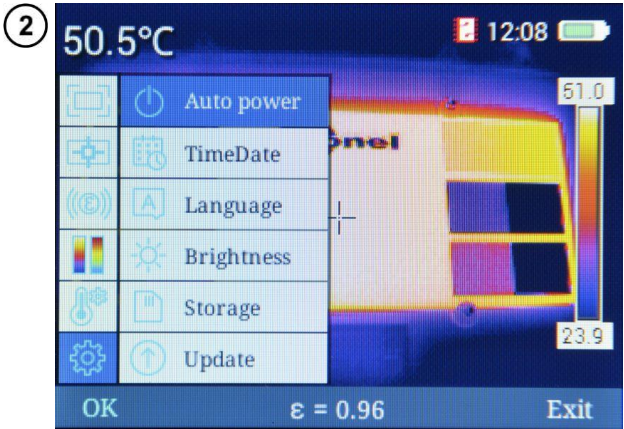

Select **System setting** option to open the sub-menu with functions needed to configure the operation of the camera.

You can select one of several options.

a. Automatic shutdown

Select **Auto power** to open the window with settings for camera automatic switch off.

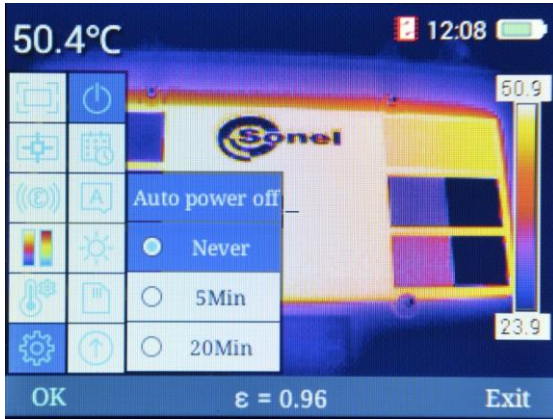

There are three settings available for Auto-OFF function of the camera:

- ⇒ **Never** – Auto-OFF function is disabled,
- ⇒ **5 min** – the camera will switch off automatically after 5 minutes of inactivity,
- ⇒ **20 min** – the camera will switch off automatically after 20 minutes of inactivity.

- Selection is made using **+** **-** buttons (UP/DOWN).
- Confirm the changes by pressing **OK** button or **▶**.
- Return without saving changes by pressing **◀** button.
- Return to the measurement mode, after introducing changes, by selecting **Exit** button.

b. Time/Date

Select **Time/Date** to open the window with fields for setting the date, time and date format.

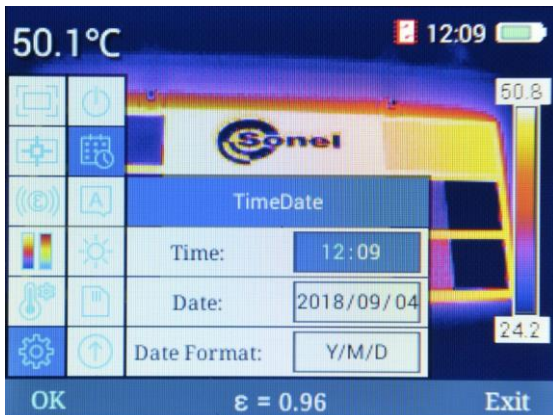

Switch between the fields using **+** **-** buttons (UP/DOWN). Use **◀▶** buttons (left/right) to activate individual parameters of a given field.

To edit the parameter in a given field, press **OK**. Then, next to the field with the edited value, the display will show mnemonic **±**. Edited value is highlighted in blue.

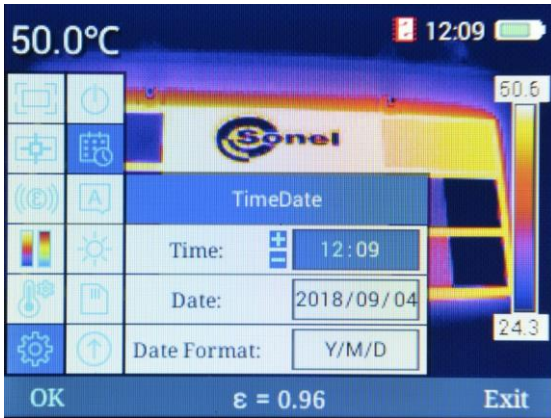

- Increase or decrease value of the parameter by pressing **+** **-** buttons (UP/DOWN).
- Changes are confirmed by pressing **OK**.
- Return to the measurement mode, without saving the changes, by pressing **Exit** button.

Three date formats are available:

- ⇒ **M/D/Y** – month/day/year,
- ⇒ **Y/M/D** – year/month/day,
- ⇒ **D/M/Y** – day/month/year.

c. Language

Select **Language** to open the window with language selection menu.

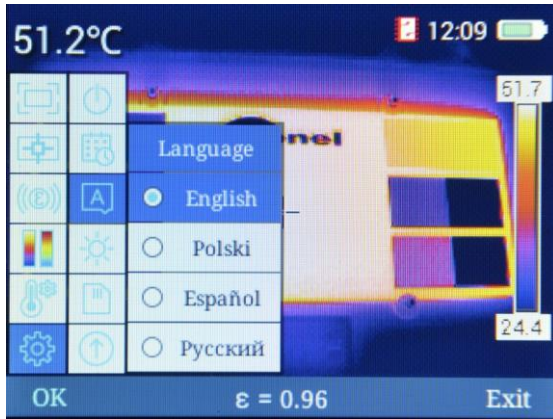

- Selection is made using **+** **-** buttons (UP/DOWN).
- Confirm the changes by pressing **OK** or **▶**. The camera will automatically return to the measurement mode.
- Return without saving changes by pressing **◀** or **Exit**



The list of available languages may be different in different versions of the camera.

d. Brightness

Select **Brightness** to open the window with the adjustment of LCD backlight.

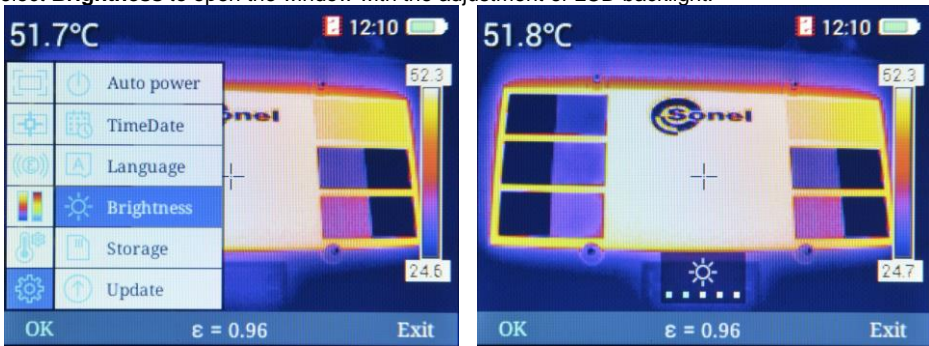

There are six display brightness modes available: 0, 1, 2, 3, 4, 5.

- Selection is made using **+** **-** buttons (UP/DOWN).
- Confirm the changes by pressing **OK** or **▶**.
- Return without saving changes by pressing **◀** button.
- Return to the measurement mode, after introducing changes, by selecting **Exit** button (Exit) or wait approx. 6 seconds without performing any activity.

e. Storage

Selecting this option allows you to select the location where the files will be saved. You can select:

- ⇒ **internal** data carrier - the internal memory of the camera,
- ⇒ **external** data carrier – SD card.

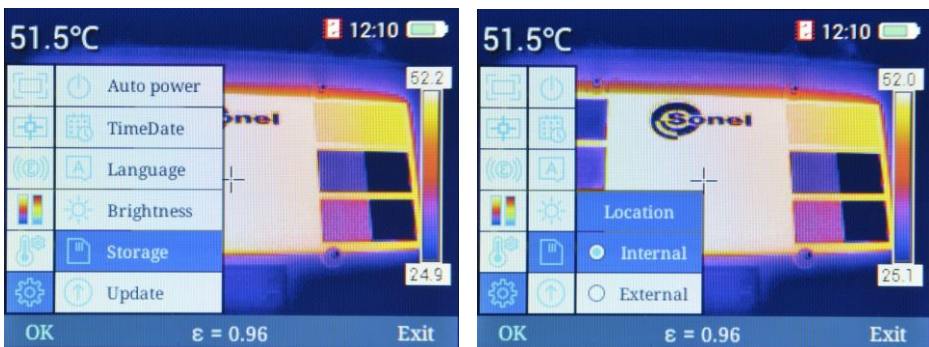

- Selection is made using **+** **-** buttons (UP/DOWN).
- Confirm the changes by pressing **OK** or **▶**.
- Return without saving changes by pressing **◀** button.

Return to the measurement mode, after introducing changes, by selecting **Exit** button (Exit).

If **internal** memory is selected, then next to the clock you will see icon .

If **external** memory is selected, then next to the clock you will see icon .

f. Update

Select this option to update the camera software/firmware. You can select:

- ⇒ software update (**Soft**),
- ⇒ firmware update (**Firmware**).

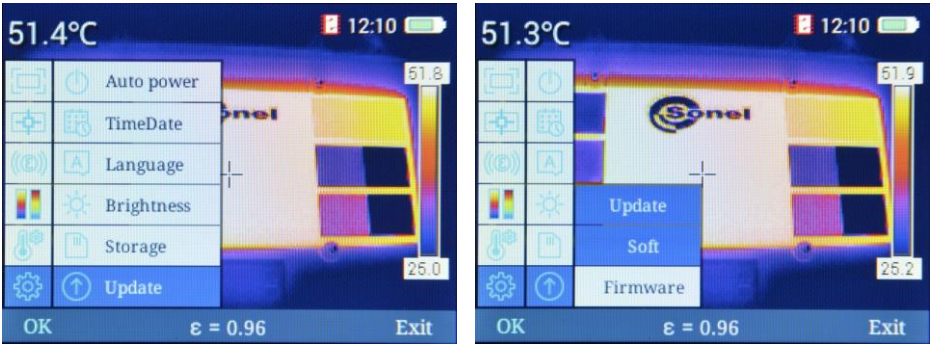

- Selection is made using **+** **-** buttons (UP/DOWN).
- Confirm the selection by pressing **↵** button (**OK**) or **▶**. Update file should be saved in **GCameraUpdate** folder in the internal memory of the camera.
- Use **◀** **▶** buttons to select **Immediate update** and confirm your selection by pressing **↵** button (**OK**). Cancel the update process by selecting **Cancel update** option.
- Return without saving changes by pressing **◀** or **↵** button (**Exit**)

g. WiFi Hotspot

Selecting this option switches the camera into wireless hotspot mode. This enables you to transfer images to the Sone! analysis software.

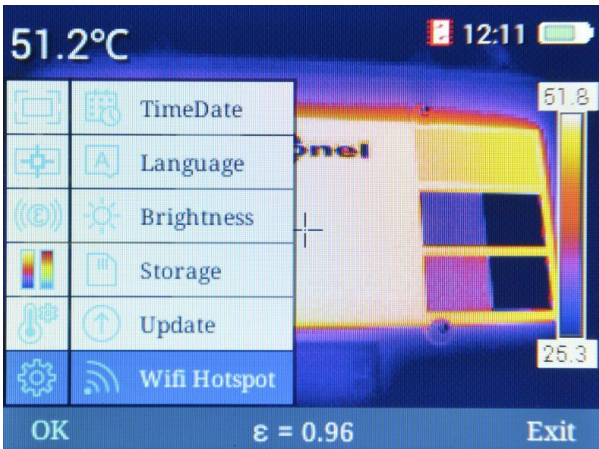

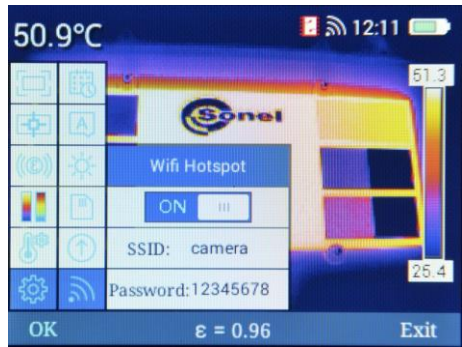
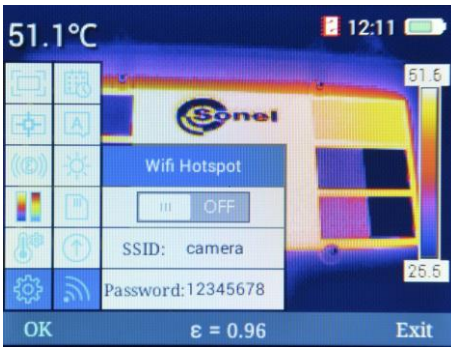

- To activate the hotspot (status: **ON**) use button or (**OK**).
- To disable the hotspot (status: **OFF**) use button (**OK**).
- Below the hotspot status symbol, the screen displays name of the wireless network name (SSID) and access password. Symbol next to the clock indicates that the mode is active.
- Return without saving changes by pressing or button (**Exit**).

h. USB Video

Selecting this option switches the camera in video transmission mode via the USB interface.

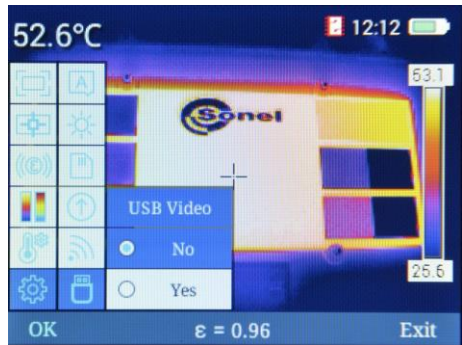
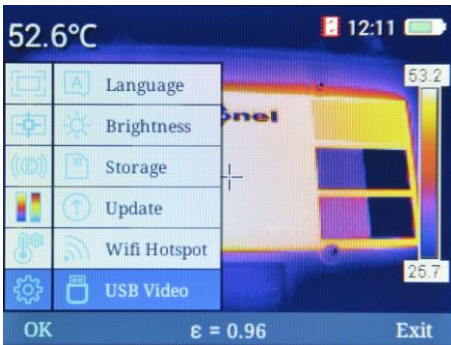

- Use buttons (UP/DOWN) to enable or disable the transfer.
- Confirm your selection by pressing button or (**OK**).
- The device will be enabled to cooperate with Sonel analysis software (**sec. 3.10**).
- Return without saving settings, by pressing or button (**Exit**)

i. **Reset Factory**

Select **Reset Factory** to return to the camera factory settings.

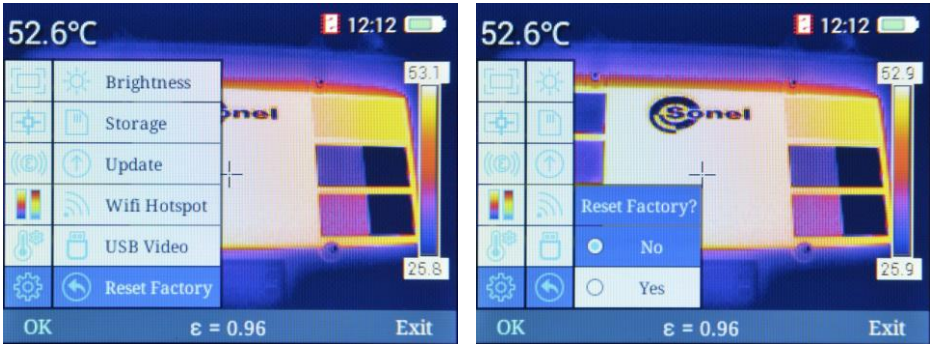

- Selection is made by pressing **+** **-** buttons (UP/DOWN).
- Confirm the changes by pressing **OK** or **▶**.
 - ⇒ Select **Yes** to restore the factory settings.
 - ⇒ Select **No** to return to MENU without restoring the settings.
- return to the measurement screen by pressing **Exit**.

If you selected **Yes**, you will be prompted to confirm the operation. Then, select the language from the menu. At the same time, the following parameters will be changed:

- emissivity factor: 0.98 (human skin),
- ambient temperature: 23°C,
- relative humidity: 70%,
- distance from the object: 3.0 m,
- colour palette: 2;
- temperature unit: °C,
- alarm temperature value: High: 350°C, Low: -20°C,
- auto-off: disabled,
- LCD brightness: 3.





CAUTION!

During the process, all files from the camera internal memory and SD card will be deleted.

j. Help

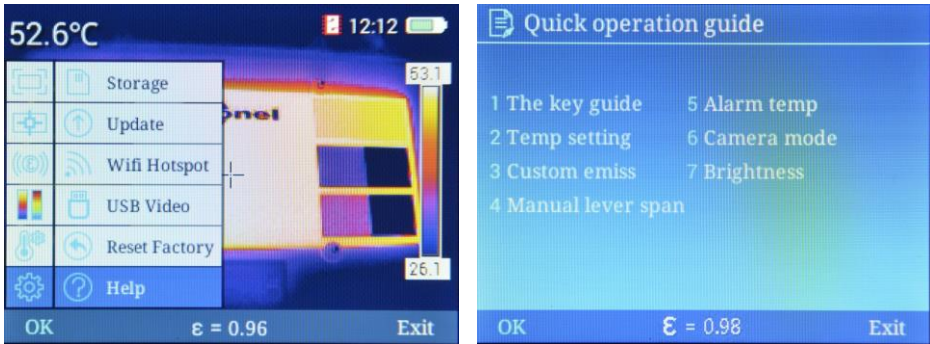
Select **Help** to open on-screen help function, which describes basic parameters and functionality of the camera.



- You can scroll the guide using ◀ ▶ buttons (left / right).
- Return to the measurement screen by pressing  button (**Exit**).

k. Version Code

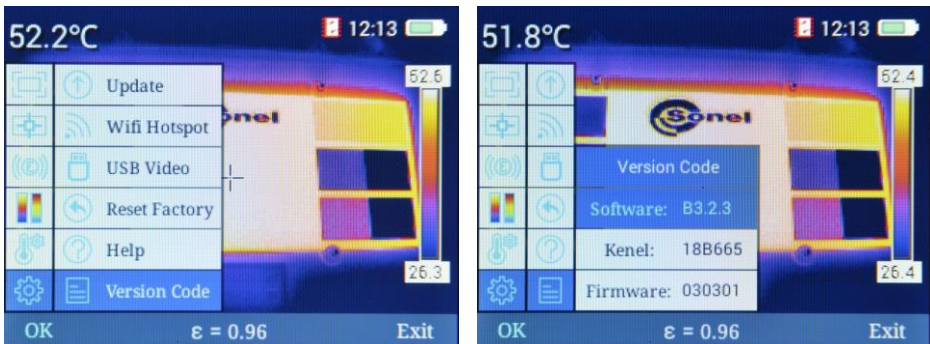

Selecting this option to see:

- ⇒ software version of the camera,
- ⇒ kernel version,
- ⇒ firmware version of the camera.

3.6 Files - viewing, deleting

①

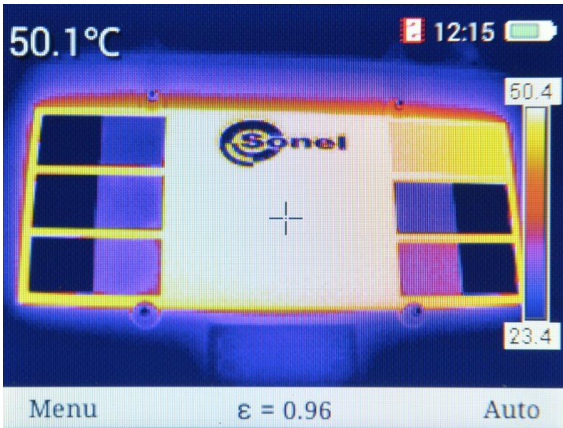

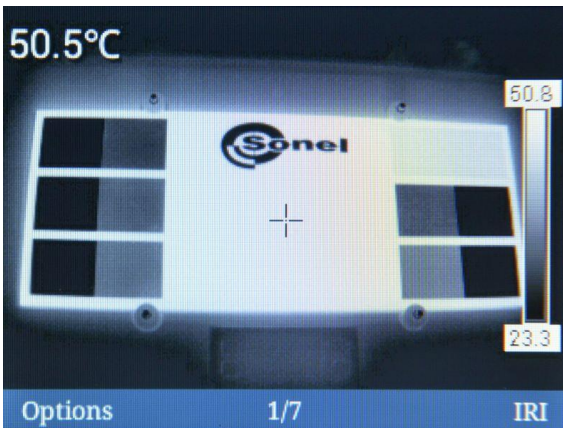

When the screen shows the bottom bar...

②





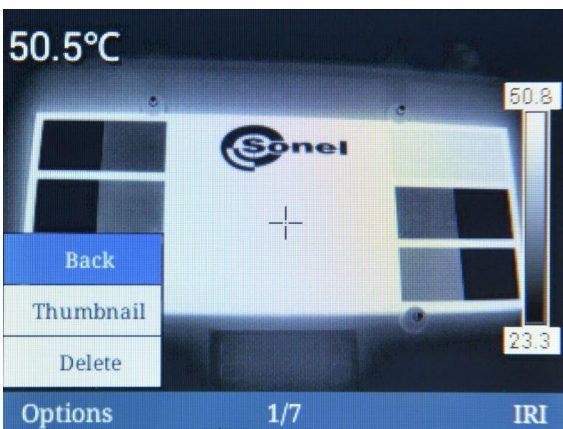

... press  button (**Display again**) to open the screen with the last recorded image.

- Press  button to switch the recorded image from infrared view to normal view (in visible light).
- Press  button (**Options**) to open menu of options.

③



• Further selection is made by pressing   buttons (UP/DOWN).



• Confirm the changes by pressing  button (**OK**) or .

• Hide menu by pressing  button.

• The bottom bar show information about the image number and the total number of images stored in the memory.

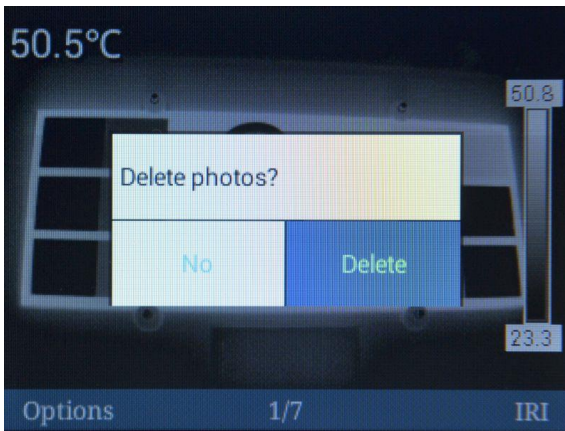
• **Back** command results in displaying the previous screen.





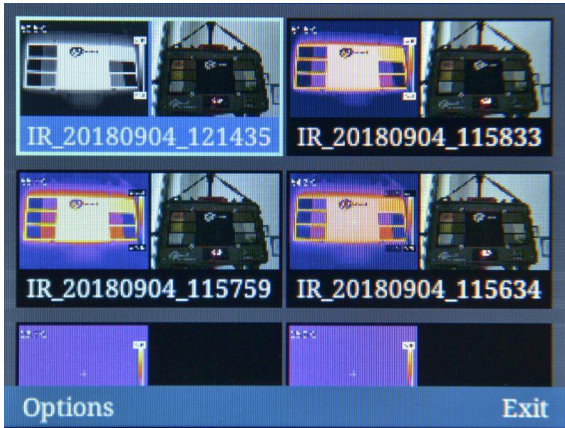

- Select **Delete** to pen the confirmation window.
- Confirm the selection by pressing ◀ ▶ buttons (left/right).
- Changes are confirmed by pressing  (**OK**):
 - ⇒ select **Delete** to delete the selected image,
 - ⇒ select **No** to return to browsing without saving changes in the memory.
- Return to the viewing images mode by pressing  button (**Exit**).

4



Select **Thumbnail** option to see a preview of images recorded in the memory.

- To select the desired image from the list, highlight it using   buttons (UP/DOWN) and  (left/right).
- Return to the measurement screen by pressing  button (**Exit**).
- Press  button (**Options**) to open menu of options.

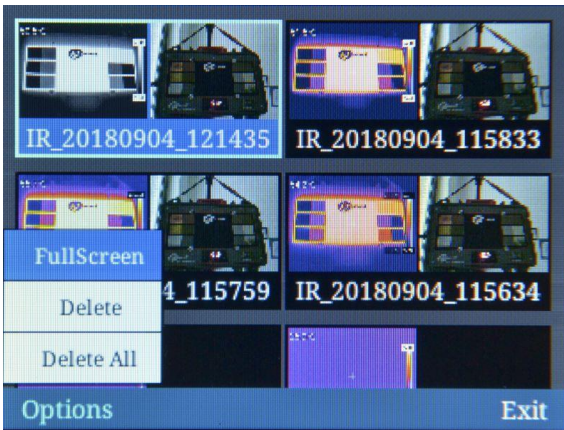

- Further selection is made by pressing **+** **-** buttons (UP/DOWN).
- Changes are confirmed by pressing **OK**:
 - ⇒ **Full Screen** option will show the selected image on the entire screen.
 - ⇒ **Delete** option opens the window for confirming the deletion of a single image.
 - ⇒ **Delete All** option opens the window for confirming the deletion of all stored images.

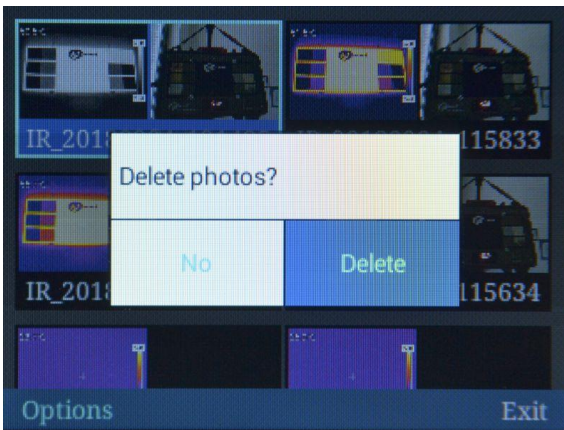

- Change your selection using **◀ ▶** buttons (left/right).
- Changes are confirmed by pressing **OK**:
 - ⇒ Select **Delete** to **remove all images stored in the currently active saving location (sec. 3.5.6e)**.
 - ⇒ Select **No** to return to browsing without saving changes in the memory.
- Return to the measurement screen by pressing **Exit** button.
- Select **Full Screen** option to activate again the full-screen preview of the selected image.

3.7 SD memory card

Thermal images are stored on a removable SD card (maximum capacity: 32 GB) or on "SD Wi-Fi". The card must be formatted in FAT32. Use only the memory card supplied with the camera.

SD card slot is located in the handle of the camera, behind the battery. The battery is also located in the handle of the camera. Both its removal and installation does not require tools.

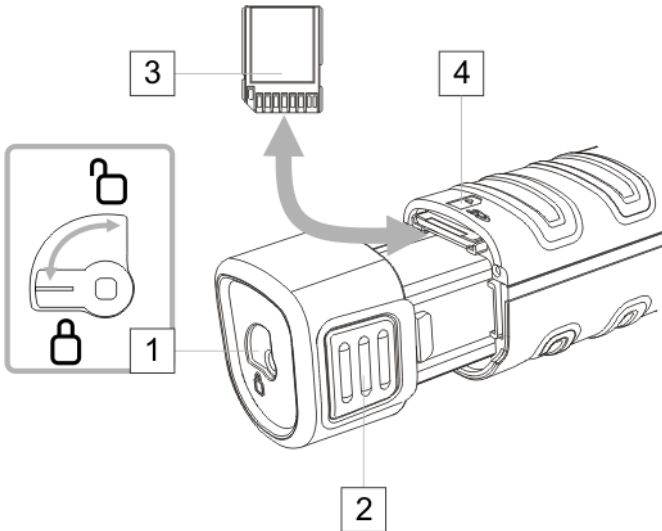

To install / remove the SD card:

- turn off the camera,
- rotate the securing catch of the battery **1** to **unlocked position**,
- evenly squeeze the battery handle **2** on both sides and pull it out of the camera,
- install the card:
 - install the card **3** as shown in the drawing **4**,
 - push the card until you hear a click,
- uninstall the card:
 - push the card until you hear a click,
 - remove the card,
- push the battery until the catches click,
- set the securing catch of the battery **1** in **locked position** (padlock closed).

3.8 Power supply, battery charging

The camera is powered by 7.4 V 2300 mAh battery. It may be also powered using the AC adapter. Rechargeable batteries in KT cameras are charged without removing them from the camera - just plug in the AC adapter to the camera microUSB socket when it is switched off. **Charging does not take place during operation of the camera.**

If the camera is to be inactive for a long time, it is recommended to recharge the rechargeable batteries every few weeks. When the camera is not used, the rechargeable batteries should be stored separately.

During the camera operation, the upper right corner of the screen shows the battery status indicator.

3.8.1 Removal /installation of the battery

The battery is located in the handle of the camera. Both its removal and installation does not require tools.

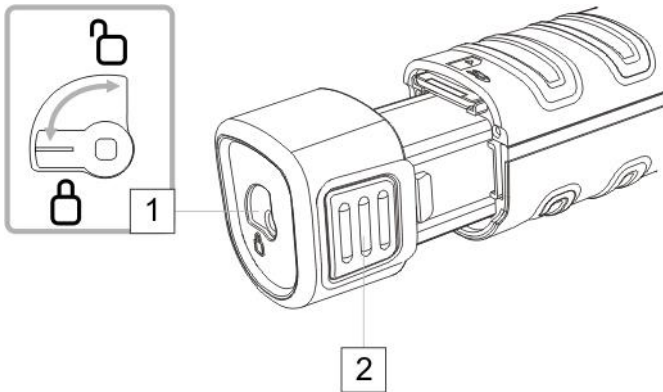

To remove the battery:

- turn off the camera,
- rotate the securing catch of the battery **1** to **unlocked position**,
- evenly squeeze the battery handle **2** on both sides and pull it out of the camera,

In order to install the battery, repeat the above process in reverse order. Always ensure that the securing catch of the battery is in **locked position** (padlock closed).

3.8.2 Using the AC adapter

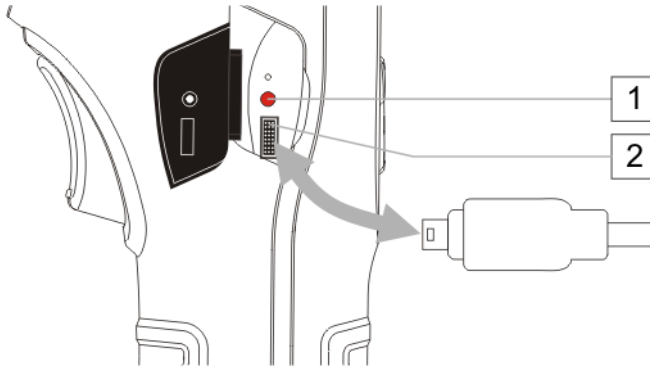

- 1 LED that indicates charging process / power supply from the USB adapter
- 2 MicroUSB socket for connecting the power supply adapter

- Plug the adapter into a power socket
- Use the supplied USB cable to connect the camera with power supply adapter

Connection of the AC adapter is indicated by LED indicator. If the camera is **switched off**, the indicator shows **in red the charging status** of the battery. When the camera is **switched on** (button  pressed longer than 3 seconds) the indicator shows **in green the power supply from the AC adapter** (battery **is not** charged). When the camera is turned off again, if the AC adapter with power supply is still connected, the indicator will indicate the battery charging again. If the power supply adapter is not used, it should be disconnected from the camera and from mains.

3.8.3 Power supply from the battery pack

After turning on the camera powered from the battery pack, the upper right corner of the screen shows the battery status indicator. During the camera operation, the battery status is indicated continuously.



3.8.4 Charging the battery pack

When the camera is turned off, and the battery pack is in the battery compartment, then connection of the AC adapter starts the charging process, which is indicated by active LED located next to the microUSB slot (in **red**). After the battery pack is charged, the LED indicator turns **green**.

Rapid flashing of the LED indicator during the charging process signals **irregularities** (e.g. battery damage). In such case, immediately **interrupt the charging process** and check the cause of the irregularities.

In the case where only irregularity is a high battery temperature, loading should be stopped until battery pack is cool.



WARNING

Never remove the battery pack from the camera while charging.



CAUTION!

- During the first use, charge the battery pack using the supplied USB charger for a minimum of 4 hours. The camera must be then **switched off**.
- Use only the AC adapter supplied with the camera.
- **Use only dedicated batteries supplied by the camera manufacturer.**
- Charging batteries should be carried out at the temperature of 0...40°C.



To maintain required parameters of the battery pack, unused battery pack should be charged every 3 months.

3.8.5 General rules for using Li-Ion rechargeable batteries

- Store the half-charged battery pack in a plastic container placed in a dry, cool and well ventilated place and protect them from direct sunlight. The battery pack may be damaged if stored when fully discharged. The ambient temperature for prolonged storage should be maintained within the range of 5°C...25°C.
- Charge the batteries in a cool, well-ventilated place at a temperature of 10°C ... 28°C. Modern fast chargers detect both too low and too high temperature of rechargeable batteries and react to the situation adequately. When the temperature is too low, charging should be prevented as it may irreparably damage the batteries. The increase in temperature of the battery pack may cause electrolyte leakage and even its ignition or explosion.
- Do not exceed the charging current, as it may result in ignition or "swelling" of the battery pack. "Swollen" battery pack must not be used.
- Do not charge or use the batteries in extreme temperatures. Extreme temperatures reduce the lifetime of rechargeable batteries. Always observe the rated operating temperature. Do not dispose the battery pack into fire.
- Li-Ion cells are sensitive to mechanical damage. This kind of damage may cause their permanent damage and thus - ignition or explosion.
- Any interference in the structure of Li-ion battery pack may cause its damage. This may result in the ignition or explosion.
- A short-circuit of the battery poles "+" and "-" may permanently damage the battery pack or even cause its fire or explosion.
- Do not immerse Li-Ion battery in liquids and do not store in humid conditions.
- If the electrolyte contained in the Lithium-Ion battery pack, contacts eyes or skin, immediately rinse the affected place with plenty of water and consult a doctor. Protect the battery against unauthorised persons and children.
- When you notice any changes in the Lithium-Ion battery pack (e.g. changes in colour, swelling, excessive temperature), stop using the battery pack. Li-Ion batteries that are mechanically damaged, overcharged or excessively discharged are not suitable for use.
- Any misuse of the battery may cause its permanent damage. This may result in the ignition. The seller and the manufacturer shall not be liable for any damages resulting from improper handling Li-Ion battery pack.

3.9 Reading data from the external memory / SD card

The contents of the card may be read by:

- connecting the camera to a PC using USB cable, or
- using SD card readers, after the card is removed from the camera.

After connecting the camera to a computer's USB port, the camera is automatically detected and installed. The camera is seen as a device installed in your computer (the drive name matches the name of the card) with two memory storage locations.

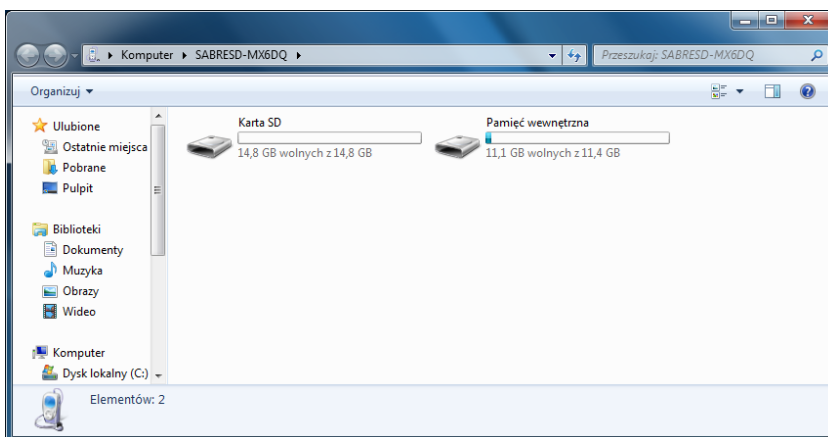
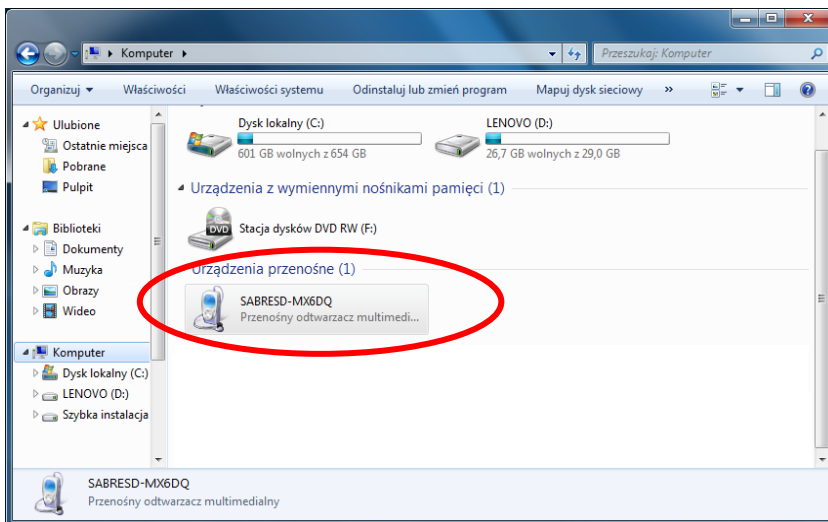

Files containing thermal images are stored in folder **\\DCIM\\GCamera**. You can copy the desired files to your computer, using Sonel ThermoAnalyze2[®] software. The procedure of opening and processing the images is described in the software manual.

It is possible to use SD Wi-Fi card, which allows you to transfer images to your computer using a wireless network. A detailed description of transferring files is contained in the manual of Sonel ThermoAnalyze2 software.

3.10 Preview of the infrared image via USB

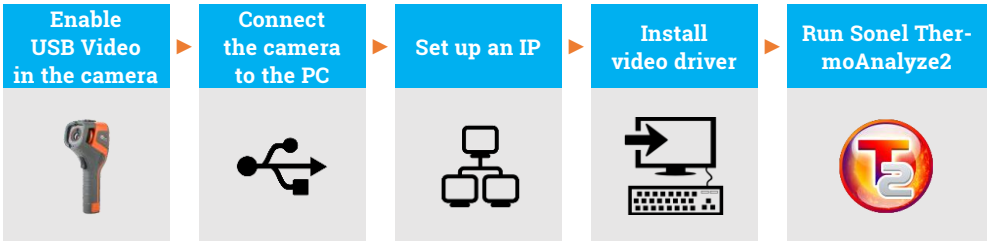

During the whole process, after connecting the camera to the PC via USB in step ②, do not disconnect it – otherwise re-connection is required. In case of need of re-connection, please first choose **No** in step ①, then **Yes** and connect the camera again. Only then the PC can recognize the device correctly.

- ① Turn on the camera. Go to **System setting** ► **USB Video** and select **Yes**.

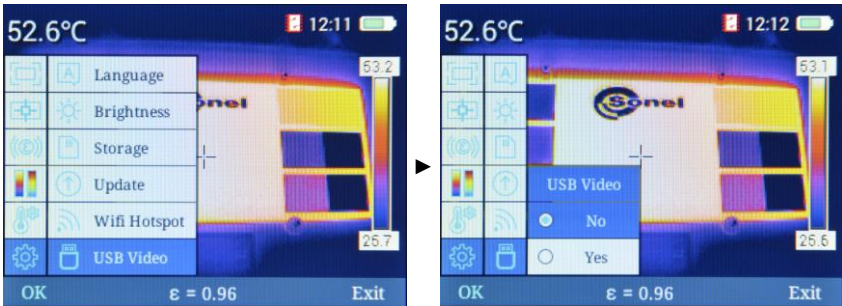

- ② Connect the camera to the PC using USB cable.

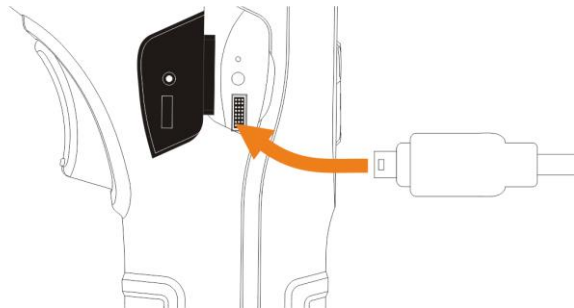

3

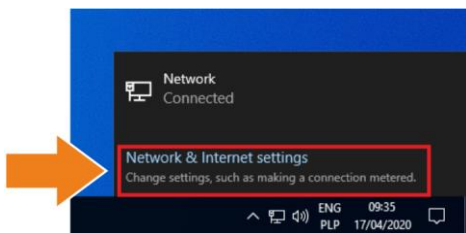

Expand network list ( or ).
Click **Network & Internet settings**.

4 Choose **Change adapter options**.

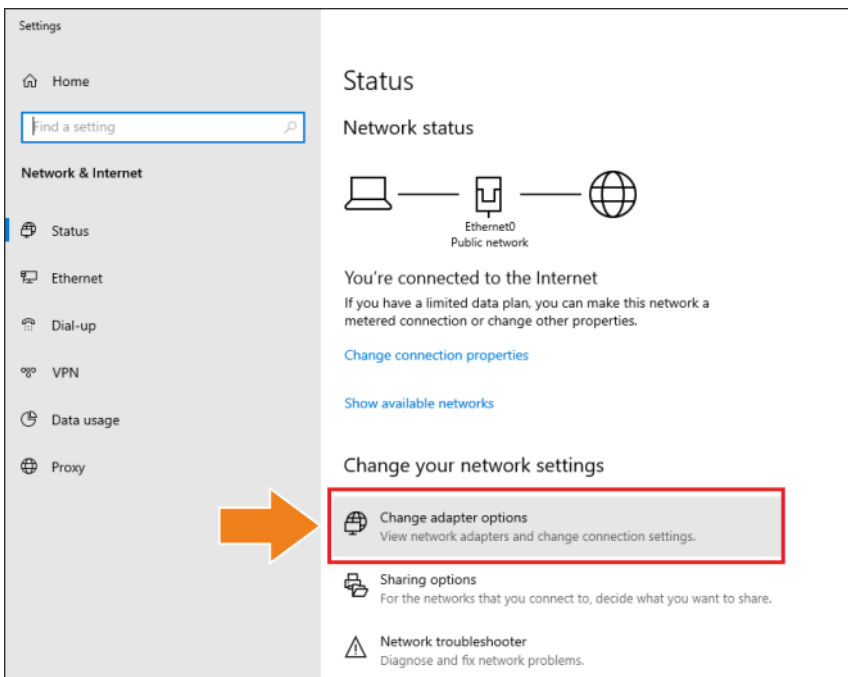

5 Right-click Ethernet4 (**Kindle USB RNDIS Device**) and choose **Properties**.

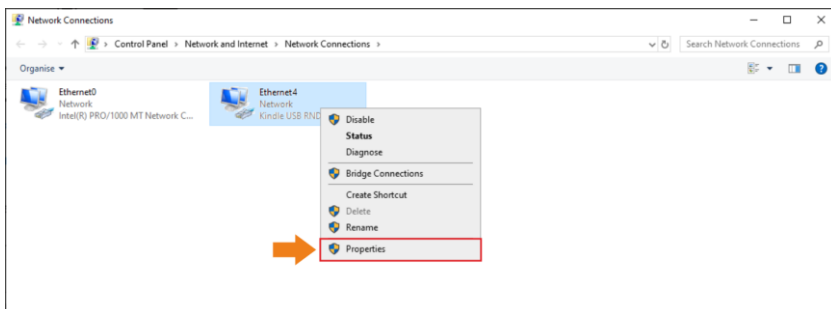

6

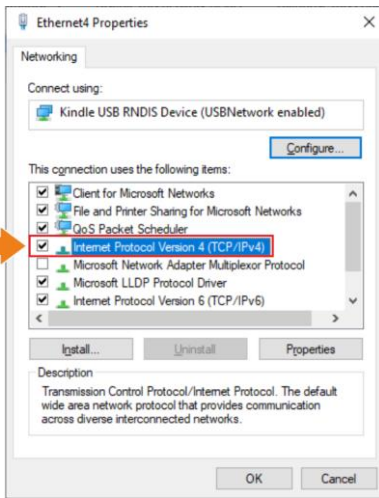

Double-click **Internet Protocol Version 4 (TCP/IPv4)**.

7

Set IP address and mask as below and confirm. The third part of IP address should be 42. The fourth part should never be 29 since the fourth part in camera IP address is 29. Click **OK**.

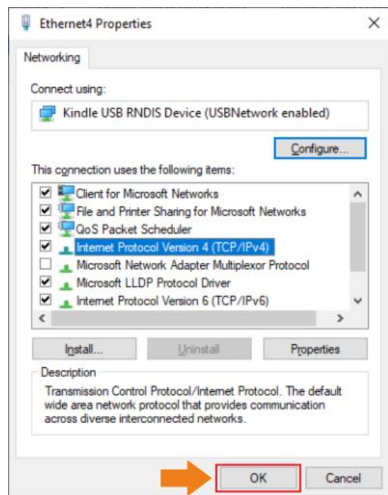
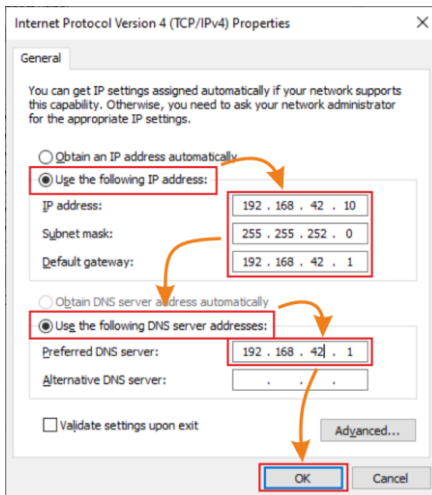

8) Now install the USB driver. Open folder **kindle_rndis.inf_amd64**.

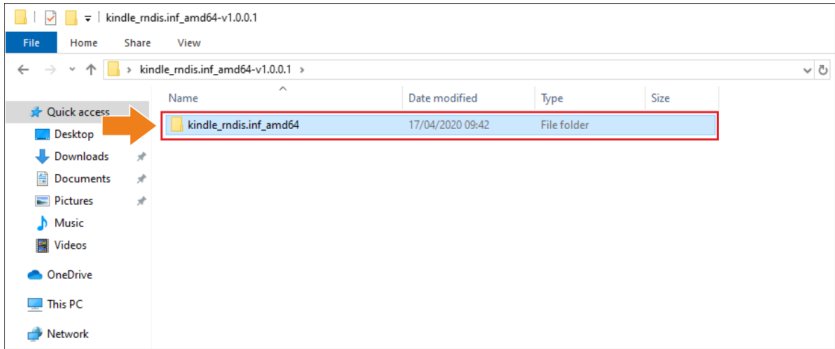

9) Right-click **5-runasadmin_register-CA-cer** and run it as administrator.

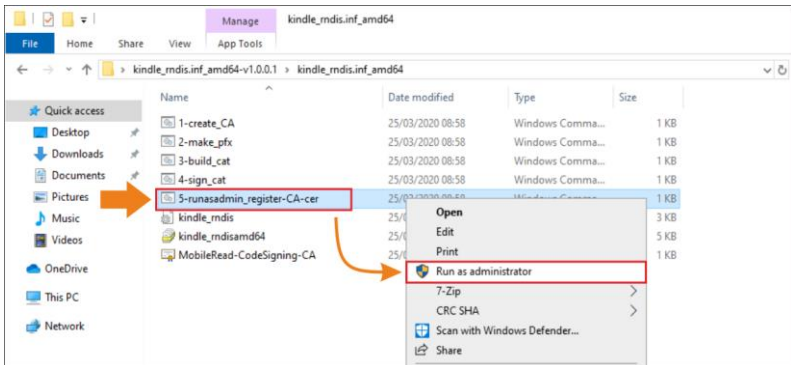

10) If the console displays messages as below, the operation was successful. Close the window.

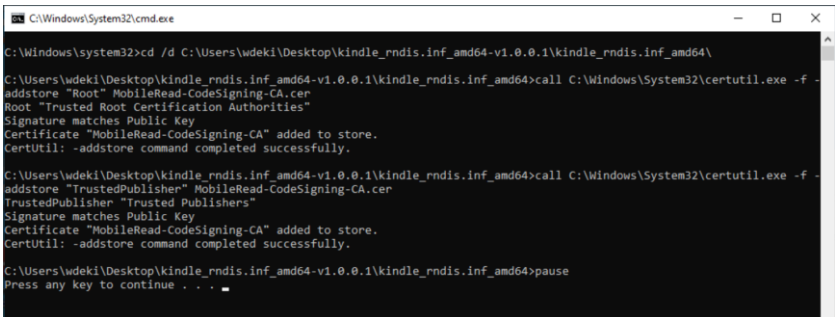

- 11 Go to device manager (Desktop ► right-click on the computer icon ► Management). If the **Kindle USB RNDIS Device (USBNetwork enabled)** is not detected properly (an unknown USB device is visible), right-click it and choose **Update driver**.

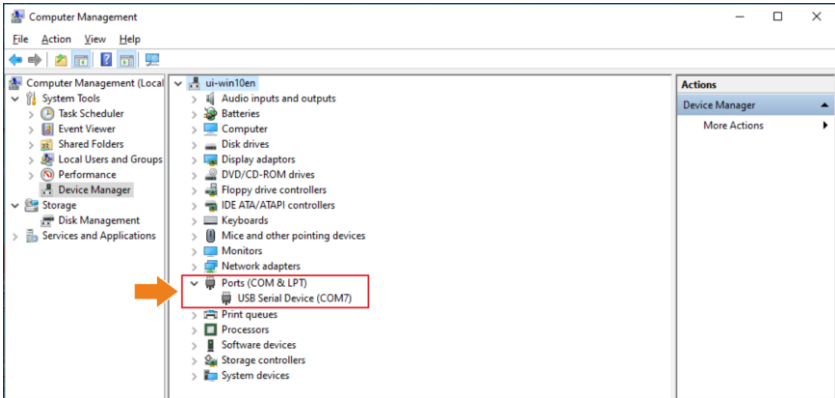

- 12 Click **Browse my computer for driver software** and then **Browse**.

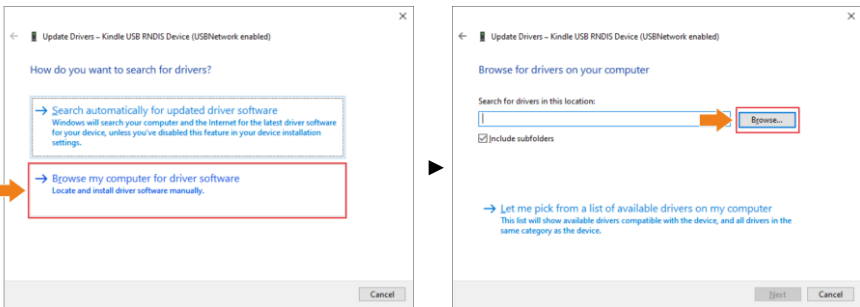

- 13 Select **kindle_rndis.inf_amd64** and click **Yes**. Then click **Next** and finish the installation.

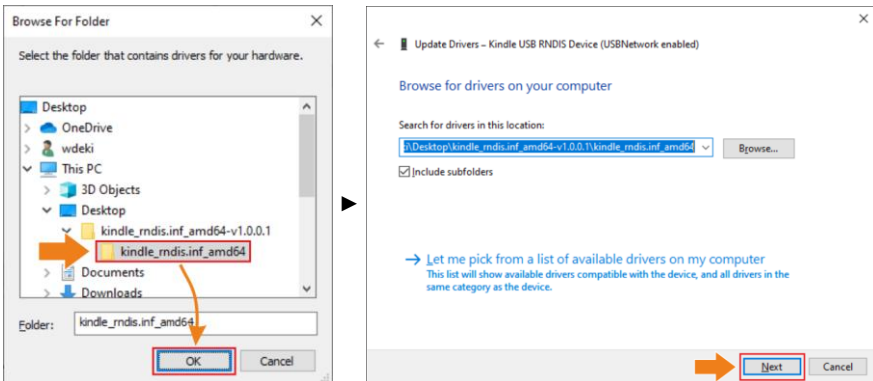

- 14 Run Sonel ThermoAnalyze2. Click **Video**, select **KT-170/400**, then **USB** and click **Confirm**.

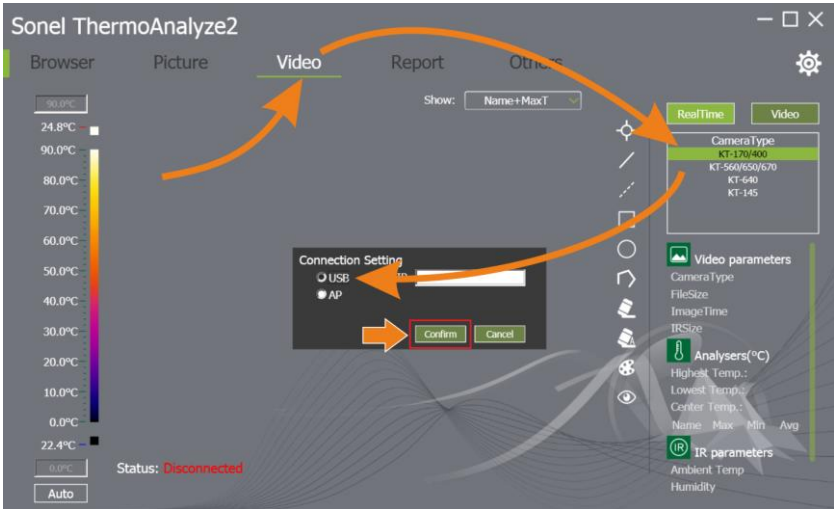

- 15 Live video is now available.

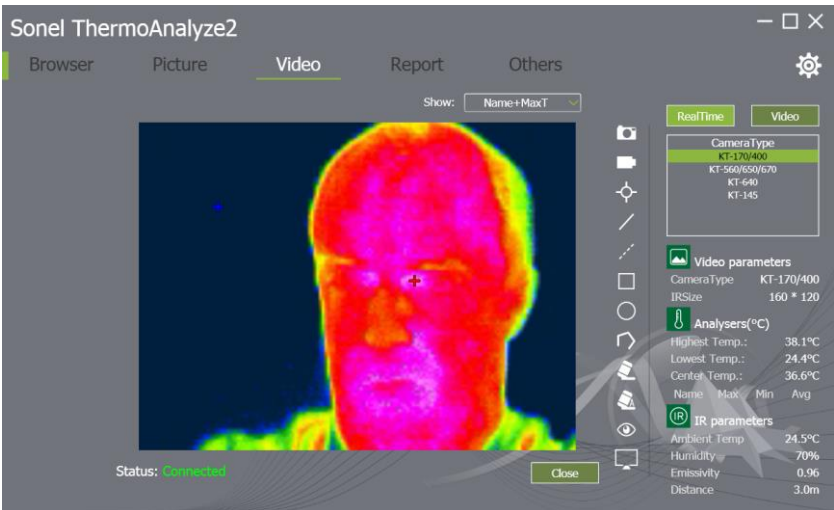

3.11 Data analysis

Sonel ThermoAnalyze2 software (supplied with the camera) allows the user to perform detailed analysis of the recorded thermal images, completed by the report. A detailed description is contained in software manual.

4 Cleaning and maintenance



NOTE!

- Use the below specified methods of maintenance only.
 - The thermal imager does not comprise any parts serviceable by the user. Do not attempt to dismantle or modify the camera on your own. **Opening the instrument voids the warranty.**
-
- Camera enclosure - all surfaces, except for optical elements of the camera, can be cleaned with a soft and moist cloth with generally available mild detergents. Do not use any solvents or cleaning agents that could scratch the enclosure (powder, paste, etc.). During cleaning, the camera must be turned off.
 - Due to the applied anti-reflective coating, optical lens are the most sensitive and at the same time the most expensive part of the camera (the lens is of key importance to radiometric capabilities of the infrared system). Therefore it is important to close the protective lens cover after each use of the camera. Optical surfaces should be cleaned only, when they are visibly fouled. Do not touch exposed surfaces of optical lens with fingers, because fouling left with fingerprints can be harmful to coatings and glass of the lens.
 - Chemical agents must not be used for cleaning the optical viewfinder, and particularly optics and accessories of the camera. Use a clean, dry and soft cloth for cleaning the body of the viewfinder; for cleaning the lens, use only the supplied lens cleaning cloth.

5 Storing

When storing the instrument, observe the following guidelines:

- make sure the camera and its accessories are dry,
- when storing the camera for a prolonged time, remove the batteries,
- allowed are storage temperatures specified in technical specifications,
- in order to avoid complete discharging of rechargeable batteries during prolonged storage, charge them once in a while (recommended time: 3 months).

6 Dismantling and disposal

- Used-up electrical or electronic equipment must be collected selectively, i.e. must not be mixed with waste of other types.
- Used-up electronic equipment must be delivered to an appropriate collection centre in accordance with regulations related to used-up electrical or electronic equipment.
- Before delivering the equipment to the collection centre do not attempt to dismantle any of its parts.
- Follow local regulations related to disposing of packaging, used-up batteries and rechargeable batteries.

7 Specifications

Model	KT-165	KT-250	KT-320
Detector resolution	160 x 120	256 x 192	320 x 240
Spectral range	7.5-14 μm		
Pixel size	12 μm	12 μm	17 μm
Thermal sensitivity	≤ 50 mK		
Focus	Fixed		
IFOV (standard lens)	3.30 mrad	2.36 mrad	2.33 mrad
Min. focus distance (standard lens)	0.5 m		
Lens (field of view/focal length)	30.0° x 22.0°/3.7 mm	35.0° x 26.0°/5 mm	42.5° x 32.5°/7 mm
Display	3.5", high brightness LCD		
Image modes	IR / visual / MIF / PiP		
Zoom	x2 / x4		
Temperature range	-20°C...650°C		
Accuracy	$\pm 2^\circ\text{C}$ or 2% of reading (for ambient temperature 15°C ...35°C and object temp. above 0°C)		
Image analysis modes	Temperature indication: min, max, temp. alarm		
Palettes	6		
Frame rate	25 Hz		
Emissivity coefficient	Selectable from 0.01 to 1.00 or from the list of materials		
Measurement adjustment	Adjustable distance, relative humidity, ambient temperature (reflected)		
File format	JPG		
Video	Image transfer via USB or Wi-Fi		
Built-in features	5 MPix visual camera		
Wireless communication	Wi-Fi		
Interface	SD card slot, microUSB 2.0		
Power supply	Li-Ion battery (over 4 h of continuous operation), built-in charger, AC adapter 110-230 V (50/60 Hz)		
Operating temperature	-10°C...50°C		
Storage temperature	-20°C...60°C		
Humidity	10% ... 95%		
Shock/vibration	30g 11ms (IEC 60068-2-27) / 10 Hz ~ 150 Hz ~ 10 Hz 0.15 mm (IEC 60068-2-6)		
Ingress protection	IP43		
Weight	approx. 0.72 kg (with battery)		
Dimensions (including standard lens and battery)	258 mm x 98 mm x 90 mm		

8 Standard accessories

Standard bundle supplied by the manufacturer includes:

- KT-165 / KT-250 / KT-320 Thermal Imager
- Li-Ion 7.4 V 2.3 Ah rechargeable battery (KT-165 – 1 piece, KT-250 – 2 pcs., KT-320 – 2 pcs.) – **WAAKU26**
- microUSB cable for data transfer – **WAPRZUSBMICRO**
- wristband – **WAPOZPAS1**
- SD card – **WAPOZSD**
- power supply (USB) for battery charging – **WAZASZ20**
- M-11 carrying case – **WAFUTM11**
- user manual
- calibration certificate issued by an accredited laboratory

The current list of accessories can be found on the manufacturer's website.

9 Manufacturer

The manufacturer and provider of warranty and post-warranty services for this instrument is:

SONEL S.A.
Wokulskiego 11
58-100 Świdnica
Poland
tel. +48 74 858 38 60
fax +48 74 858 38 09
e-mail: export@sonel.pl
web page: www.sonel.pl



NOTE!

Only the manufacturer is authorized to perform service repairs.

10 Laboratory services

SONEL Testing and Calibration Laboratory has been accredited by the Polish Center for Accreditation (PCA) - certificate no. AP 173.

Laboratory offers calibration for the following instruments that are used for measuring electrical and non-electrical parameters.



AP 173

● METERS FOR MEASUREMENTS OF ELECTRICAL PARAMETERS

- voltage meters,
- current meters (including clamp meters),
- resistance meters,
- insulation resistance meters,
- earth resistance and resistivity meters,
- RCD meters,
- short-circuit loop impedance meters,
- power quality analyzers,
- portable appliance testers (PAT),
- power meters,
- multimeters,
- multifunction meters covering the functions of the above-mentioned instruments,

● ELECTRICAL STANDARDS

- calibrators,
- resistance standards,

● METERS FOR MEASUREMENTS OF NON-ELECTRICAL PARAMETERS

- pyrometers,
- thermal imagers,
- luxmeters.

The **Calibration Certificate** is a document that presents a relation between the calibration standard of known accuracy and meter indications with associated measurement uncertainties. The calibration standards are normally traceable to the national standard held by the National Metrological Institute.

According to ILAC-G24 „Guidelines for determination of calibration intervals of measuring instruments”, SONEL S.A. recommends periodical metrological inspection of the instruments it manufactures no less frequently than once every **12 months**.

For new instruments provided with the Calibration Certificate or Validation Certificate at the factory, re-calibration should be performed within **12 months** from the date of purchase, however, no later than **24 months** from the date of purchase.



ATTENTION!

The person performing the measurements should be absolutely sure about the efficiency of the device being used. Measurements made with an inefficient meter can contribute to an incorrect assessment of the effectiveness of health protection and even human life.

11 Exemplary emissivity coefficient values

aluminum.....	0.05	lead: polished.....	0.08
aluminum Rough.....	0.07	lead: grey.....	0.28
aluminum oxidized.....	0.25	lead: oxidized.....	0.63
asphalt.....	0.90	paper white.....	0.90
asbestos board.....	0.96	paper black glossy.....	0.90
asbestos (fiber).....	0.78	paper black dull.....	0.94
akelite.....	0.93	paper: tarred.....	0.92
bronze: dull.....	0.22	plastic: black.....	0.95
bronze: polished.....	0.10	platinum.....	0.10
bronze: rough.....	0.55	porcelain: glazed.....	0.92
brick: glass, rough.....	0.85	mercury.....	0.10
brick: fireproof, rough.....	0.94	lampblack.....	0.96
cement.....	0.54	silver.....	0.03
cement (concrete).....	0.90	steel: galvanized.....	0.28
chrome.....	0.15	steel: oxidized.....	0.88
chrome polished.....	0.10	steel: rolled freshly.....	0.24
tin.....	0.09	steel: rolled.....	0.56
zinc.....	0.05	steel: rough.....	0.96
brick red.....	0.93	steel: rusty red.....	0.69
paint: oil.....	0.94	steel nicked.....	0.11
clay: fired.....	0.91	glaze.....	0.90
clay.....	0.40	glass.....	0.92
graphite.....	0.85	glass dull.....	0.96
ground: frozen.....	0.93	snow.....	0.80
rubber.....	0.93	tape insulation.....	0.95
cobalt.....	0.18	fabric.....	0.85
quartz.....	0.93	titanium.....	0.30
lacquer white.....	0.87	carbon.....	0.90
lacquer polished black.....	0.87	charcoal powder.....	0.96
lacquer dull black.....	0.97	tungsten.....	0.13
lacquer silver.....	0.31	tungsten: oxidized.....	0.11
ice.....	0.97	gold.....	0.02
magnesium.....	0.12	iron: glossy.....	0.16
copper: oxidized.....	0.65	iron: heat rolled.....	0.77
copper: oxidized black.....	0.88	iron: oxidized.....	0.74
copper: polished.....	0.07	iron: polished.....	0.23
copper: polished annealed.....	0.01...0.02	iron and steel: oxidized.....	0.85
brass.....	0.10	cast: raw casting.....	0.81
brass: oxidized.....	0.61	cast: polished.....	0.21
nickel : polished.....	0.05		

Values given above can vary depending on the conditions in which measurements were taken.

NOTES

NOTES

NOTES

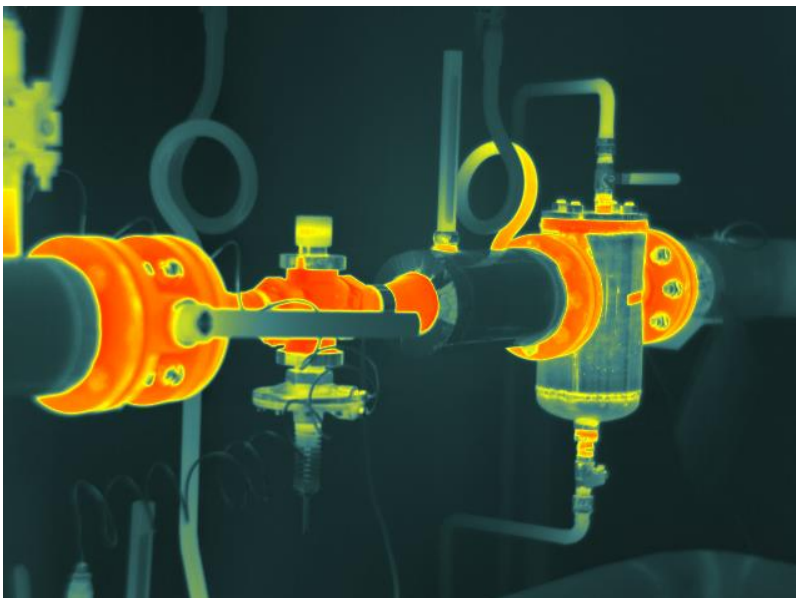

SONEL S.A.

Wokulskiego 11
58-100 Świdnica
Poland

+48 74 858 38 60
+48 74 858 38 00
fax: +48 74 858 38 09

e-mail: export@sonel.pl
internet: www.sonel.pl